

KP Rep / Matt,

MPMC00029



**MOUNT POLLEY MINING CORPORATION
MOUNT POLLEY MINE**

**STAGE 6 DESIGN OF THE TAILINGS STORAGE FACILITY
(REF. NO. VA101-01/18-1)**

Rev. No.	Revision	Date	Approved
0	Issued for Report	June 18, 2007	<i>KPB</i>

Knight Piésold Ltd.

Suite 1400
750 West Pender Street
Vancouver, British Columbia
Canada V6C 2T8

Telephone: (604) 685-0543
Facsimile: (604) 685-0147
E-mail: kpl@knightpiesold.com

Knight Piésold
CONSULTING

**MOUNT POLLEY MINING CORPORATION
MOUNT POLLEY MINE**

**STAGE 6 DESIGN OF THE
TAILINGS STORAGE FACILITY
(REF. NO. VA101-01/18-1)**

EXECUTIVE SUMMARY

The Mount Polley Copper and Gold mine is owned by Mount Polley Mining Corporation (MPMC). It is located 56 kilometres northeast of Williams Lake, in central British Columbia. Mount Polley mine re-opened in March 2005 after managing the facilities on a Care and Maintenance basis since mining activities were temporarily suspended in October 2001. MPMC is currently mining the Bell and Wight Pits with the tailings material being deposited as slurry into the Tailings Storage Facility (TSF). Process water is collected and recycled back to the mill for recycle in the milling process.

This report provides supporting documentation to allow for MPMC to permit the staged expansion of the TSF embankments from the existing permitted elevation of 951 m for the Stage 5 expansion to a new Stage 6 elevation of 958 m. The Stage 6 design of the TSF is consistent with the general design and construction methodology for the TSF and consists of adding 7 m to the current crest elevation of the embankments using the modified centreline construction method. This elevation will provide sufficient storage in the TSF for approximately two years of operations while maintaining the required water storage and freeboard requirements. Detailed design reports, construction drawings, technical specifications, and construction reports are prepared for each stage of the TSF expansions by Knight Piésold.

The instrumentation at the TSF consists of vibrating wire piezometers and inclinometers. No unexpected or anomalous pore pressures have been observed while monitoring the vibrating wire piezometers during the TSF construction programs and there have been no significant deviations in the inclinometers since they were installed.

A Dam Safety Review (DSR) for the Tailings Storage Facility was completed by AMEC in October 2006. The results of the DSR were issued in a report to Imperial Metals Corporation in December 2006. The DSR review concluded that the Mount Polley TSF is adhering to an excellent dam safety program. The DSR confirmed that the TSF is performing as designed and meets or exceeds the guidelines set forth by the appropriate guidelines for dam safety. The DSR also provided recommendations concerning the hazard classification, design storm, pond and beach management, instrumentation, and the foundation stability at the Main Embankment. These DSR recommendations are discussed in this report.

Although the Stage 6 design of the TSF is consistent with the general design and construction methodology, there are a few modifications to the design resulting from the DSR and discussions with MPMC, which include:

- Reducing the low permeability core width from 8 m to 5 m.
- Implementing the downstream buttress at the Main Embankment.

The Stage 6 design also includes an upstream toe drain at the South Embankment. Upstream toe drains have previously been installed along the Main and Perimeter Embankments. The upstream toe drains are effective in lowering the phreatic surface, which increases embankment stability and seepage control. The upstream toe drains also remove a certain amount of filtered water from the impoundment, and it may be possible to establish water discharge points below the seepage collection ponds if water quality objectives are met.

Recent mine plans indicate that the total resource for the Mount Polley Mine has increased to approximately 100 million tonnes. This is an increase of 15 million tonnes over the total capacity of 85 million tonnes previously referenced in the Knight Piésold Report "Design of the Tailings Storage Facility to Ultimate Elevation", Ref. No. VA101-1/8-1, March 14, 2005. The ultimate elevation of the TSF will be approximately 970 m, depending on the volume of water stored in the TSF supernatant pond.

**MOUNT POLLEY MINING CORPORATION
MOUNT POLLEY MINE**

**STAGE 6 DESIGN OF THE
TAILINGS STORAGE FACILITY
(REF. NO. VA101-01/18-1)**

TABLE OF CONTENTS

	PAGE
EXECUTIVE SUMMARY	i
TABLE OF CONTENTS	i
SECTION 1.0 - INTRODUCTION	1
1.1 PROJECT DESCRIPTION	1
1.2 SCOPE OF REPORT	1
1.3 REFERENCES	2
SECTION 2.0 - TAILINGS STORAGE FACILITY	3
2.1 GENERAL	3
2.2 FOUNDATION CONDITIONS	4
2.3 TAILINGS AND RECLAIM PIPELINES	4
2.4 EMBANKMENT DRAINAGE PROVISIONS	5
2.5 SEEPAGE COLLECTION PONDS	6
2.6 INSTRUMENTATION	6
2.7 WATER MANAGEMENT	7
SECTION 3.0 - STAGE 6 TAILINGS STORAGE FACILITY DESIGN	8
3.1 GENERAL	8
3.2 STABILITY ANALYSES	9
3.3 SEEPAGE ANALYSES	10
3.4 STAGE 6 TSF CONSTRUCTION	11
SECTION 4.0 - CERTIFICATION	12

TABLES

Table 3.1 Rev 0	Stage 6 Design Basis and Operating Criteria
Table 3.2 Rev 0	Embankment Material Quantities Estimate

FIGURES

Figure 1.1 Rev 0	Project Location and Access Plan
Figure 1.2 Rev 0	Aerial Photograph of Mount Polley Mine – Viewing North

Figure 1.3 Rev 0 Aerial Photograph of Mount Polley Mine – Viewing South
Figure 3.1 Rev 0 Filling Schedule

DRAWINGS

Drawing 101-1/18-100 Rev 0	TSF – Stage 6 Tailings Embankment - Overall Site Plan
Drawing 101-1/18-102 Rev 0	TSF - Stage 6 Tailings Embankment - General Arrangement
Drawing 101-1/18-104 Rev 0	TSF - Stage 6 Tailings Embankment - Material Specifications
Drawing 101-1/18-210 Rev 0	TSF - Stage 6 - Main Embankment - Plan
Drawing 101-1/18-215 Rev 0	TSF - Stage 6 Main Embankment - Section
Drawing 101-1/18-220 Rev 0	TSF - Stage 6 Perimeter Embankment - Plan
Drawing 101-1/18-225 Rev 0	TSF - Stage 6 Perimeter Embankment – Section
Drawing 101-1/18-230 Rev 0	TSF - Stage 6 South Embankment - Plan
Drawing 101-1/18-235 Rev 0	TSF - Stage 6 South Embankment – Sections
Drawing 101-1/18-240 Rev 0	TSF - Stage 6 South Embankment – Upstream Toe Drain – Sections and Details
Drawing 101-1/18-251 Rev 0	TSF – Stage 6 - Main Embankment - Instrumentation Plan
Drawing 101-1/18-252 Rev 0	TSF - Stage 6 - Perimeter Embankment - Instrumentation Plan
Drawing 101-1/18-253 Rev 0	TSF - Stage 6 - South Embankment - Instrumentation Plan
Drawing 101-1/18-256 Rev 0	TSF - Stage 6 - Instrumentation - Main Embankment – Planes A and B
Drawing 101-1/18-257 Rev 0	TSF - Stage 6 - Instrumentation - Main Embankment – Planes C and E
Drawing 101-1/18-258 Rev 0	TSF - Stage 6 - Instrumentation - Perimeter Embankment – Planes D, G and H
Drawing 101-1/18-259 Rev 0	TSF - Stage 6 - Instrumentation – South Embankment - Planes F and I

APPENDICES

APPENDIX A	Overview of 2006 Dam Safety Review
APPENDIX B	Instrumentation Monitoring
APPENDIX C	Upstream Toe Drain Seepage Estimations

**MOUNT POLLEY MINING CORPORATION
MOUNT POLLEY MINE**

**STAGE 6 DESIGN OF THE
TAILINGS STORAGE FACILITY
(REF. NO. VA101-01/18-1)**

SECTION 1.0 - INTRODUCTION

1.1 PROJECT DESCRIPTION

The Mount Polley Copper and gold mine is owned by Mount Polley Mining Corporation (MPMC). It is located 56 kilometres northeast of Williams Lake, in central British Columbia. The project site is accessible by paved road from Williams Lake to Morehead Lake and then by gravel road for the final 12 km. The location of Mount Polley Mine is shown on Figure 1.1. Mount Polley Mine started production in 1997 and had milled approximately 27.5 million tonnes of ore prior to temporarily suspending operations from October 2001 to March 2005. MPMC is currently mining the Bell and Wight Pits with the tailings material deposited as slurry into the Tailings Storage Facility (TSF). Process water is collected and recycled back to the mill for recycle in the milling process. The mine throughput is approximately 20,000 tpd. Aerial photographs of the Mount Polley Mine obtained in October 2005 are shown on Figures 1.2 and 1.3. The overall Mount Polley Mine site plan is shown on Drawing 100. The general arrangement of the TSF is shown on Drawing 102.

1.2 SCOPE OF REPORT

MPMC is currently in the process of raising the TSF embankments to the currently permitted Stage 5 expansion elevation of 951 m. Knight Piésold provided the design, technical specifications, and QA/QC for the Stage 5 expansion. The scope of this report is to provide supporting documentation to allow MPMC to obtain permits for the Stage 6 expansion of the TSF embankments to an elevation of 958 m. This elevation will provide sufficient storage in the TSF for approximately two years of operations while maintaining the required water storage and freeboard requirements. The Stage 6 design of the TSF consists of adding 7 m to the Stage 5 crest elevation of the embankments using the modified centreline construction method. The Stage 6 construction of the TSF will take place over a two year period to better utilize the waste materials from the mining operations as construction materials for the TSF embankments. The drawings contained within this report are for permitting support and will be updated prior to being "Issued for Construction".

This report also discusses and addresses the recommendations provided in the Dam Safety Review completed by AMEC in 2006. The DSR recommendations and the Knight Piésold comments are located in Appendix A.

The design of the TSF to an elevation of 965 m was issued in the Knight Piésold Report "Design of the Tailings Storage Facility to Ultimate Elevation", Ref. No. VA101-1/8-1, March 14, 2005. This elevation will provide sufficient storage in the TSF for approximately 85 million tonnes of tailings while maintaining the required water storage and freeboard requirements. The mine plan has recently been updated and the total resource has been increased to approximately 100 million tonnes. This will require the tailings embankments to be constructed to an elevation of approximately 970 m, depending on the volume of the supernatant pond.

1.3 REFERENCES

This report references the following documents, which provide key supplementary information:

AMEC "Dam Safety Review", December 2006.

Bell, G., Fell, R., MacGregor, P. and Stapledon, D. 2005. Geotechnical Engineering of Dams. Chapter 13, p. 554 to 557.

Knight Piésold Report "Design of the Tailings Storage Facility to Ultimate Elevation", Ref. No. VA101-1/8-1, March 14, 2005.

Knight Piésold Report "Updated Design Report", Ref. No. 1627/2, June 6, 1997.

MAJM Corporation Ltd., Report to Imperial Metals Corporation, "Geotechnical Review, Drainage Aspects Main Embankment Dam, Tailings Storage Facility Report," March 1997.

SECTION 2.0 - TAILINGS STORAGE FACILITY

2.1 GENERAL

The principal objectives of the TSF are to provide secure containment for tailings solids and to ensure that the regional groundwater and surface water flows are not adversely affected during or after mining operations. The design and operation of the TSF is integrated with the overall water management objectives for the entire mine development, in that surface runoff from disturbed catchment areas is controlled, collected and contained on site. An additional requirement for the TSF is to allow effective reclamation of the tailings impoundment and associated disturbed areas at closure to meet land use objectives.

The main components of the TSF are as follows:

- The TSF embankments incorporate the following zones and materials:
 - Zone S - Core zone - fine grained glacial till.
 - Zone U – Upstream shell zone – parameters vary depending on material availability.
 - Zone CS - Upstream shell - cycloned or spigotted tailings sand.
 - Zone B - Embankment shell zones - fine grained glacial till.
 - Zone F - Filter, drainage zones, and chimney drain - processed sand and gravel.
 - Zone T - Transition filter zone - select well-graded fine-grained rockfill.
 - Zone C - Downstream shell zone – rockfill.
- A low permeability basin liner (natural and constructed) covers the base of the entire facility, at a nominal depth of at least 2 m. The low permeability basin liner has proven to be effective in minimizing seepage from the TSF as there have been no indications of adverse water quality reporting to the groundwater monitoring wells.
- A foundation drain and pressure relief well system, located downstream of the Stage 1B Main Embankment. The foundation drain and pressure relief well system prevent the build-up of excess pore pressure in the foundation, and transfer groundwater and/or seepage to the collection ponds.
- Seepage collection ponds located downstream of the Main and Perimeter Embankments and a seepage collection sump located downstream of the South Embankment. The ponds/sump were excavated in low permeability soils and collect water from the embankment drains and from local runoff.
- Instrumentation in the tailings, earthfill embankments and embankment foundations. This includes vibrating wire piezometers, and slope inclinometers.
- A system of groundwater quality monitoring wells installed around the TSF.

The tailings embankments have been designed for staged expansion using the modified centreline construction method.

2.2 FOUNDATION CONDITIONS

The tailings basin is generally blanketed by naturally occurring well-graded low permeability glacial till, which functions as an in-situ soil liner. However, a basin liner was constructed just upstream of the Main Embankment during Stage 1a to ensure that the basin liner had a minimum thickness of 2 m throughout the tailings basin. The constructed basin liner was tied into the Main Embankment core zone and the existing basin liner where the in-situ thickness exceeded 2 m.

The south ridge between the Main and South Embankments was investigated during the Stage 4 construction program to confirm the thickness of natural low permeability glacial till in this area. The investigation found that the glacial till thickness was less than the required minimum of 2 m near the crest of the ridge. A basin liner was constructed in this area during the Stage 4 construction program to ensure a minimum thickness of 2 m of dense low permeability till extends throughout this area and that it tied into the South Embankment core zone.

The foundation conditions at the Main Embankment consist of low permeability glacial till material at surface underlain by fluvial and lacustrine silts up to 20 m thick. The foundation piezometers at the Main Embankment indicate that this area has slight artesian conditions (less than 3.0 m). The foundation conditions at the Perimeter Embankment consist of low permeability glacial till throughout that is generally in excess of 5 m thick. The foundation conditions at the South Embankment consist of a relatively thin, low permeability glacial till material overlying bedrock. Details of the site geological investigations can be found in the Knight Piésold Report "Updated Design Report", Ref. No. 1627/2, June 6, 1997.

Laboratory testwork on the foundation soils indicates that the materials have adequate shear strength to ensure foundation stability of the embankments. The lacustrine unit at the Main Embankment is being investigated further and samples have been collected for direct shear testing to confirm the shear strength of this material.

Artesian pressures were identified in the foundation soils at the Main Embankment during initial investigations prior to TSF construction. Pressure relief wells were installed previously at this location to depressurize the underlying glaciofluvial deposits. Ongoing monitoring has confirmed that design objectives are being met during on-going operations as the foundation pore pressures have remained at the baseline level.

2.3 TAILINGS AND RECLAIM PIPELINES

The tailings pipeline comprises 7 km of HDPE pipe of varying diameters and pressure ratings extending from the mill down to the crest of the tailings embankment and has a design flow of 20,000 tonnes/day at 35% solids by dry weight. The tailings pipeline has a single, movable discharge section, which allows for controlled deposition of tailings from an isolated section of the embankment to evenly distribute tailings from around the perimeter of the facility. Evenly discharging the tailings from around the facility optimizes the development of tailings beaches and keeps the supernatant pond clear of the embankments, thereby enhancing embankment stability, increasing seepage paths and limiting seepage loss from the facility. Beached tailings,

when left to drain and consolidate, form the competent foundations needed for the modified centreline construction embankment raises. The minimum recommended tailings beach width is at least 20 m along the abutments of the embankments (where the embankment contacts natural ground) and at least 10 m elsewhere to separate the pond from the embankments. Tailings material was also being used during the Stage 4 and Stage 5 construction programs as Zone U material upstream of the core zone.

The reclaim pipeline system returns water from the TSF to the mill site for re-use in the process. The system comprises a pump barge, a reclaim pipeline and a reclaim booster pump station.

2.4 EMBANKMENT DRAINAGE PROVISIONS

Embankment drainage provisions have been incorporated into the design of the TSF to facilitate drainage of the tailings mass, dewater the foundation soils, and to control the phreatic surface within the embankments. The components of the drainage systems consist of foundation drains, chimney drains, longitudinal drains, outlet drains, and upstream toe drains. The conveyance pipework for all of the drains terminates in the drain monitoring sumps at the Main and Perimeter Embankments where the drain flows and water quality are monitored. A drain monitoring sump was installed at the South Embankment during the Stage 5 construction program. The drainage systems are reviewed as part of the annual inspection and as part of each design phase for the expansion of the TSF. The drainage provisions for the TSF are as follows:

Foundation Drains - A system of foundation drains was installed in the Main and Perimeter Embankment foundations to improve the foundation conditions and enhance the dewatering of near surface soils. Pressure relief wells and pressure relief trenches connected to the foundation drains depressurize the underlying glaciofluvial deposits and enhance the stability of the embankment.

Chimney, Longitudinal and Outlet Drains - Chimney drains have been included in the Main, Perimeter and South Embankments. The chimney drains provide a contingency drainage measure for control of the phreatic surface in the embankments and will also function as a crack stopper downstream of the core zone. Water collected in the chimney drains is routed to the drain monitoring sumps via the longitudinal and outlet drains.

Upstream Toe Drains - Upstream toe drains have previously been installed in the Main and Perimeter Embankments and one is planned for installation in the South Embankment during the Stage 6 construction program. The purpose of the upstream toe drains is to drain and consolidate the tailings mass near the embankments. The inclusion of upstream toe drains also provides seepage control within the embankment and reduces the likelihood of piping. Piezometer records at the Main Embankment indicate that the upstream toe drain is effective in draining the sandy tailings adjacent to the embankment.

The upstream toe drains also remove a certain amount of filtered water from the impoundment, and it may be possible to establish water discharge points below the seepage collection ponds if water quality objectives are met. Experience at the site has shown that the quality of water

flowing from the toe drains is better than supernatant water quality for most parameters, largely because the suspended solids are effectively filtered by the sandy tailings solids as the water seeps into the drains. The benefits of the upstream toe drains were recognized during an independent third party review conducted by Fred Matich of MATM in 1997 in a "Geotechnical Review, Drainage Aspects" for the Main Embankment.

An upstream toe drain will be constructed at the South Embankment and the outlet pipeworks will be constructed in in-situ foundation materials at approximately chainage 31+00. The conduit will consist of a concrete encased pipe, with the concrete encasement having sloped sides to allow for superior compaction of the earthfill materials against it. A filter diaphragm consisting of Zone F material will be constructed for seepage and piping control (Geotechnical Engineering of Dams, 2005). Flows from the South Embankment upstream toe drain will flow into the Main Embankment Seepage Collection Pond via a ditch. A weir will be installed in the ditch to measure the flows.

2.5 SEEPAGE COLLECTION PONDS

The seepage collection ponds collect water from the embankment drain systems and from local runoff. The Main Embankment Seepage Collection Pond, located immediately downstream of the Main Embankment, was completed at the start of the initial Stage 1a construction program during 1997. The Perimeter Embankment Seepage Collection Pond was excavated during Stage 1b construction in 1997. These ponds were excavated in low permeability glacial till materials. A sump and a seepage recycle pumpback system were installed at the South Embankment during Stage 5.

2.6 INSTRUMENTATION

Piezometers

Vibrating wire piezometers have been installed at the TSF along nine planes designated as Monitoring Plans A to I. The monitoring planes for the Main Embankment, the Perimeter Embankment, and the South Embankment are shown on Drawings 251, 252, and 253 respectively. The piezometer locations for the monitoring planes are shown in section on Drawings 256 to 259. The piezometers are grouped into tailings, foundation, embankment fill and drain piezometers.

The piezometer readings are included in Appendix B. No unexpected or anomalous pore pressures have been observed.

Inclinometers

Five slope inclinometers have been installed to date at the toe of the Main Embankment through the lacustrine silts to measure potential foundation deformation due to embankment loading. Three of the inclinometers were installed during the Stage 4 construction program. One of the two original inclinometers installed in 2001 was damaged during extension of the casing when

shell zone material was being placed and is no longer functional. There have been no significant movements identified in the inclinometers since they were installed. The inclinometer readings are summarized in Appendix B.

Survey Monuments

Survey monuments are only installed on the TSF embankments when construction activities are suspended for a long enough time period to allow reasonable records to be obtained. Survey monuments will be installed following the Stage 6 construction program if there is a sufficient break in the construction activities between the Stage 6 and Stage 7 construction programs.

2.7 WATER MANAGEMENT

MPMC mine personnel complete on-going surface water monitoring and water management activities to ensure compliance with the current mine permits. The water balance for the TSF is updated regularly by MPMC with periodic reviews by Knight Piésold. The site climatic conditions were reviewed by Knight Piésold in 2004 and the water balance input parameters were adjusted to better reflect site conditions. The TSF is currently operating with a water budget surplus, as total inflows from precipitation and surface runoff exceed losses from evaporation, void retention and seepage removal.

The TSF is also required to have sufficient live storage capacity for containment of storm water runoff from the 72-hour PMP volume of 1,070,000 m³ at all times. This extreme storm water runoff would result in an incremental rise in the tailings pond level of approximately 0.6 m. The 72-hour PMP allowance is in addition to regular inflows from other precipitation runoff, including the spring freshet. Previous TSF designs incorporated an additional allowance of 1 meter of freeboard for wave run-up. The freeboard requirement for wave run-up has been reduced to 0.7 m, for a total updated freeboard requirement of 1.3 m. This is consistent with the previous total freeboard requirement of 1.4 m. However, MPMC has elected to maintain the previous freeboard requirement of at least 1.4 m for the remaining mine life. The freeboard requirement post closure will be reviewed as part of the closure and reclamation plans as they are updated.

MPMC is currently exploring ways to discharge water from the site to reduce the ongoing storage requirements in the TSF as all of the surplus water is currently being stored in the TSF. The TSF filling curve and ultimate height of the TSF assume that there is no discharge of water during operations. This would result in the volume of the tailings pond progressively increasing to approximately 7 to 8 million m³ at the end of mine operations, prior to closure unless water is discharged during operations. It is noted that a discharge from the TSF would be required at closure and it will be beneficial to implement an appropriate treatment/discharge strategy during operations so that an appropriate system is proven over several years of operations.

SECTION 3.0 - STAGE 6 TAILINGS STORAGE FACILITY DESIGN

3.1 GENERAL

The Stage 6 expansion of the TSF will involve raising the crests of each of the embankments by 7 m to an elevation of 958 m. This will provide storage for tailings and water for approximately two years of operations. The construction of the TSF embankments consists of expanding the embankments using the modified centreline construction method. The design basis and operating criteria for the Stage 6 design of the TSF are shown on Table 3.1. The filling schedule and anticipated staged construction sequence of the TSF is shown on Figure 3.1. The filling schedule has been updated and extended to year 2015 to reflect the current mine plan.

Construction activities to be completed during the Stage 6 expansion of the TSF will include the following:

- Expanding Zones S, F, T, U and C to elevation 958 m. The Zone S core zone will have a minimum width of 5 m. The Zone S core has been reduced from 8 m as the upstream toe drains have proved to be effective in lowering the phreatic surface upgradient of the embankments. Zones F and T will be tied into the existing Zones F and T to ensure that the filter and transition materials are continuous.
- Installing an upstream toe drain on the South Embankment to drain and consolidate the tailings mass near the embankment. The flows from the South Embankment upstream toe drain will be routed to the Main Embankment Seepage Collection and Recycle pond via a ditch.
- Constructing a buttress downstream of the Main Embankment to elevation 925 m to ensure that the required Factor of Safety is achieved for the Stage 6 embankment configuration.
- Extending the slope inclinometers at the Main Embankment concurrently with the downstream shell zone.
- Installing additional vibrating wire piezometers in the embankment fill and tailings materials, as well as installing additional piezometers in the foundation materials at the Main Embankment. The piezometer cables will be extended to readout boxes located beyond the ultimate toe of the embankments. The proposed locations of the new piezometers are shown on Drawings 256 to 259.
- Relocating the south surface water diversion ditch and access road above elevation 970 m.

The Stage 6 Main Embankment Plan, Section and Details are shown on Drawings 210 and 215 respectively. The Stage 6 Perimeter Embankment Plan, Section and Details are shown on Drawings 220 and 225, respectively. The Stage 6 South Embankment Plan and Sections are shown on Drawings 230 and 235, respectively. The material specifications are shown on Drawing 104. Details of the upstream toe drain at the South Embankment are shown on Drawing 240.

3.2 STABILITY ANALYSES

Stability analyses for the TSF embankments were performed using the limit equilibrium computer program SLOPE/W. The stability analyses were updated to reflect the updated 2005 National Building Code Seismic Hazard calculation by Natural Resources Canada, which has increased the seismic ground motions (peak accelerations). Accordingly, the OBE and the MDE have increased to 0.07g and 0.096g respectively. The OBE and MDE are defined as the 1/475 year and the 1/1000 year events respectively based on a Canadian Dam Association hazard classification of LOW. The adopted MDE is from the high end of the LOW classification. The stability analyses were also completed to identify the buttress requirements at the Main Embankment should a weak layer exist in the lacustrine material. The piezometers installed in the lacustrine material indicate slight artesian conditions within this material. The stability analyses were completed with the elevated pore pressures in the lacustrine unit (approximately 2.5m above ground).

Material parameters adopted for the tailings, foundation and earth embankment materials are based on testwork from the 1995 and 1997 geotechnical investigations, from the various quality control records obtained during construction of previous embankment stages, and from experience with typical values for similar materials. The analyses were completed to model the downstream stability and conservatively assumed low strengths for the upstream tailings mass.

The results of the SLOPE/W stability analyses indicate that the factor of safety for the Stage 6 TSF embankments for static conditions was 1.4 for the Main Embankment, 1.7 for the Perimeter Embankment, and 1.8 for the South Embankment. The stability analysis for the Main Embankment includes a downstream buttress constructed to an elevation of 925 m. A study comparing the drained residual strength to the clay content, liquid limit, and effective normal stress was completed by Stark and Eid (1995). The results of the study indicate that the residual strength of a material with a clay content ranging from 25 to 50%, with a liquid of 40%, and an effective normal stress of 700 kPa is in the order of 24 degrees. A conservative friction angle of 24 degrees was applied for the lacustrine unit.

A stability analysis was also completed for the Main Embankment with a crest elevation of 970 m to determine the buttress requirements to meet the closure Factor of Safety objective of 1.5. The results indicate that the buttress will need to be increased to an approximate elevation of 942 m for closure conditions. The required elevation of the buttress will increase from Stage 6 through closure as the embankment gets higher. MPMC should consider constructing the buttress as non-reactive waste material is made available from the development of the open pits to avoid having to develop a rock borrow in the later years of the mine life to construct the buttress.

The seismic analyses included determination of the critical yield acceleration defined as the acceleration required to reduce the Factor of Safety to 1.0. The results of the stability analyses indicate that the critical acceleration for the Stage 6 Main, Perimeter and South Embankments is 0.12g, 0.25g and 0.26g respectively. The critical acceleration for the Main Embankment at closure is 0.13g. The OBE and MDE peak ground accelerations are 0.07g and 0.096g respectively. The maximum accelerations within the tailings embankment and foundations will be

slightly higher due to local amplification of ground motion. A dynamic response (Shake) analysis was completed for the Main Embankment indicating that amplification of ground motion increases the average ground acceleration by approximately 50 %. Simplified Newmark, Makdisi-Seed, and Swaisgood analyses were completed to estimate potential embankment deformations. A conservative average maximum acceleration of 0.15g along the potential slip surface was used. The deformations will be negligible for the MDE (in the order of 1 cm). Limited deformation of the TSF embankment is acceptable under seismic loading from the MDE, provided that the overall stability and integrity of the facility is maintained and that there is no release of stored tailings or water (ICOLD, 1995). The TSF embankments would be expected to remain functional during and after the OBE and any resulting damage should be easily repairable in a limited period of time.

A post liquefaction analyses was also completed to provide a conservative assessment of the downstream stability of the TSF embankments assuming the tailings material liquefies and has a very low residual strength. The factors of safety for the Main Embankment (the critical embankment as it is the largest) for post liquefaction conditions was 1.4.

The factors of safety for the upstream stability analyses for static, seismic, and under post liquefaction conditions for the Main Embankment were greater than 2.0.

The results of the stability analyses indicate that the Stage 6 and final TSF embankments are stable under static, seismic, and post liquefaction conditions and that the embankments do not rely on the tailings mass for stability.

A stability analysis was also completed to establish a trigger level for the foundation piezometers at the Main Embankment where artesian conditions exist. The trigger level corresponds to the elevated pore pressure that reduces the Factor of Safety to 1.1. The results of the analyses indicate that the trigger level for the Main Embankment foundation piezometers is 15 m above ground.

3.3 SEEPAGE ANALYSES

The seepage analyses was completed using the computer program SEEP/W to delineate the phreatic surface and pore pressures within the tailings mass and the embankment fill materials. The seepage analyses are also used to estimate the seepage from the embankment drainage systems to the seepage collection ponds and also to estimate the unrecoverable seepage from the TSF. Seepage analyses were recently completed by Knight Piésold to estimate the flows from the upstream toe drains installed in the Main, Perimeter, and South Embankments. The results of the seepage analyses were issued in a letter to MPMC, which is included in Appendix C. The results indicated that the flows from the upstream toe drains, assuming that all three drains are in operation, ranges from approximately 17 l/s to 52 l/s.

Additional seepage analyses were completed for the TSF with a crest elevation of 970 m. These seepage analyses were completed with a 5 m and an 8 m wide low permeability core width to

evaluate the difference in TSF seepage associated from the reduction in the core width. The seepage analyses assumed a minimum operating tailings beach width of 10 m.

The results of the seepage analyses indicate the upstream toe drains intercept the majority of the seepage through the embankment and the flows into the upstream toe drains are unaffected by the reduced core width. This result was expected as the toe drains are located upstream of the core zone. The seepage results indicate that the reduction in the low permeability core width from 8 m to 5 m above elevation 951 m will have no impact on the magnitude of seepage losses from the TSF embankments.

3.4 STAGE 6 TSF CONSTRUCTION

The Stage 6 construction program involves expanding Zones S, F, T, U and C to elevation 958 m. over a two year period. The estimated quantities for the TSF Stage 6 expansion, as well as the continued expansion of the TSF to elevation 970, are shown on Table 3.2.

The construction of the TSF assumes that the Zone U will be constructed using sand cells. The sand cells involved discharging tailings into constructed cells upstream of the embankment. The confining berms have culverts installed into them to allow for the water and fine materials to exit the cells and flow into the TSF. The coarse tailings sand that settles out into the cells are constantly worked with a dozer to ensure proper distribution within the cells, to compact the sand and to expedite the drainage of excess water through the culverts. This method of constructing Zone U proved to be effective for Stage 4 and 5.

The lift thickness and compaction requirements for each of the construction materials are shown on Drawing 104. Knight Piésold will provide the construction drawings, technical specifications, and QA/QC for the Stage 6 expansion of the TSF. Knight Piésold will also issue a construction report within six months of the completion date of the Stage 6 construction program.

SECTION 4.0 - CERTIFICATION

This report was prepared and approved by the undersigned.

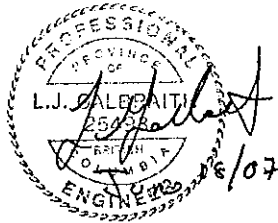

Prepared by:

Les Galbraith, P.Eng.
Senior Engineer

Approved by:

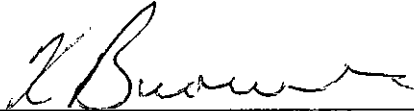

Ken J. Brouwer, P.Eng.
Managing Director

This report was prepared by Knight Piésold Ltd. for the account of Mount Polley Mining Corporation. The material in it reflects Knight Piésold's best judgement in light of the information available to it at the time of preparation. Any use which a third party makes of this report, or any reliance on or decisions to be made based on it, is the responsibility of such third parties. Knight Piésold Ltd. accepts no responsibility for damages, if any, suffered by any third party as a result of decisions made or actions, based on this report. This numbered report is a controlled document. Any reproductions of this report are uncontrolled and may not be the most recent revision.

TABLE 3.1

MOUNT POLLEY MINING CORPORATION
MOUNT POLLEY MINE

STAGE 6 DESIGN BASIS AND OPERATING CRITERIA

Print: 18-Jun-07
Revised: 15-May-07

M:\1\01\00001\18\A\Report\Tables\Table 3.1.Doc

ITEM	DESIGN CRITERIA
1.0 GENERAL DESIGN CRITERIA	
Regulations	MEM, WLAP
Codes and Standards	ASTM, ACI, ANSI, CSA, CDSA, HSRC (Health, Safety and Reclamation Code for Mines in BC), NBC and related codes
Design Operating Life	8.5 Years (as of 2007)
Tailings Production Information	20,000 tonnes/day, 35% solids, 2.65 SG, 100 million tonnes total production, 1.40 tonnes/m ³ final average tailings dry density
Hazard Rating:	LOW by CDA Consequence Classification/British Columbia Dam Safety Regulation of the Water Act. Revised from HIGH in 2007 based on the Dam Safety Review. Owners costs not included in the Hazard Rating.
Site Elevation	910 to 1150 metres
Climate	Average Annual Rainfall = 740 mm, Annual Evaporation = 423 mm, Mean Annual Temp = 4.0 C (Likely), 24-hour PMP storm = 203 mm. 72-hour PMP storm = 320 mm.
Updated Design Earthquakes ¹ : OBE (operations) MDE (closure)	1 in 475 Year Event (M = 6.5, A _{max} = 0.070 g). 1 in 1000 Year Event or MCE (M = 6.5, A _{max} = 0.096 g).
Seepage Control	Low permeability glacial till liners (natural and constructed) in basin, with foundation drain system below main embankment. Foundation and chimney drain seepage is contained within the seepage collection ponds.
Tailings Pipework	Butt fusion welded HDPE pipe, gravity flow, discharge predominantly from embankment, spill containment by gravity flow to tailings basin.
2.0 TAILINGS BASIN	
Geological and Geotechnical Conditions	The TSF basin and foundation comprises glacial soils of variable permeability and strength.
Basin Liner	<ul style="list-style-type: none"> In-situ low permeability glacial till, or Constructed glacial till liner. Required in areas with <2 m depth of in-situ glacial till.
Embankment Foundation Drains	<ul style="list-style-type: none"> Installed in Main and Perimeter Embankment foundations. Foundation drain installed at the South Embankment during the Stage 5 expansion. Foundation drains discharge to the seepage collection ponds at the Main and Perimeter Embankments via drain monitoring sumps. The foundation drain at the South Embankment discharges to a sump where the flows are monitored and pumped back to the TSF.
Stripping	<ul style="list-style-type: none"> Required at areas directly affected by construction (embankments, basin liners, seepage collection ponds, reclaim

¹ Design Earthquakes updated in 2007 to reflect the 2005 NBC Seismic Hazard Calculation by Natural Resources Canada.

TABLE 3.1

**MOUNT POLLEY MINING CORPORATION
MOUNT POLLEY MINE**

STAGE 6 DESIGN BASIS AND OPERATING CRITERIA

Print: 18-Jun-07

Revised: 15-May-07

M:\1101\00001\118\A\Report\Tables\Table 3.1.Doc

	<ul style="list-style-type: none"> • barge channel stockpiles, road, etc). • Remove organic soil to topsoil stockpiles 						
3.0 TAILINGS EMBANKMENT							
Function	<ul style="list-style-type: none"> • Storage of tailings and process water for design life • Provide emergency containment of runoff for 72-hour PMP storm. • Provision for routing PMF at closure 						
Embankment Crest Width	5m min for Zone S.						
Embankment Height:	<table border="0"> <tr> <td>Stage 5</td> <td>El. 951 m (scheduled for completion July 31, 2007)</td> </tr> <tr> <td>Stage 6</td> <td>El. 958 m</td> </tr> <tr> <td>Final</td> <td>El. 970 m (base on 100,000,000 tonnes)</td> </tr> </table>	Stage 5	El. 951 m (scheduled for completion July 31, 2007)	Stage 6	El. 958 m	Final	El. 970 m (base on 100,000,000 tonnes)
Stage 5	El. 951 m (scheduled for completion July 31, 2007)						
Stage 6	El. 958 m						
Final	El. 970 m (base on 100,000,000 tonnes)						
Design Tonnage	7,300,000 tpy (20,000) tpd						
Solids Content of Tailings Stream	35% (before Millsite and waste dump runoff added to tailings stream)						
Freeboard:	<table border="0"> <tr> <td>Operations</td> <td>1.4 m -- includes for the 72-hour PMP event plus 0.7m for wave run. (as per the Dam Safety Review)</td> </tr> <tr> <td>Closure</td> <td>Sufficient to provide routing of PMF plus wave run-up.</td> </tr> </table>	Operations	1.4 m -- includes for the 72-hour PMP event plus 0.7m for wave run. (as per the Dam Safety Review)	Closure	Sufficient to provide routing of PMF plus wave run-up.		
Operations	1.4 m -- includes for the 72-hour PMP event plus 0.7m for wave run. (as per the Dam Safety Review)						
Closure	Sufficient to provide routing of PMF plus wave run-up.						
Storage Capacity	100 million tonnes (Crest Elevation of 970 m).						
Tailings Density:	1.4 t/m ³						
Tailings Specific Gravity	2.65						
Emergency Spillway Flows:	<table border="0"> <tr> <td>Operations</td> <td>Not required.</td> </tr> <tr> <td>Closure</td> <td>Design flow for routing PMF event.</td> </tr> </table>	Operations	Not required.	Closure	Design flow for routing PMF event.		
Operations	Not required.						
Closure	Design flow for routing PMF event.						
Filling Rate	Refer to Figure 2.1. -- Stage 6 to design is for 2 years of operations.						
Fill Material / Compaction Requirements	Refer Drawing 101-1/18-104.						
Sediment Control	Primary control provided by the TSF Embankments. Secondary control provided by the seepage collection ponds.						
Seepage Control	Seepage collection ponds and pumpback systems.						
Spillway Discharge Capacity	Not required during operations.						
Surface Erosion Protection	Re-vegetation with grasses on final reclaimed embankment slopes.						
4.0 PIPEWORKS							
4.1 Tailings Pipeworks							
Function	Transport tailings slurry and mill site and waste dump runoff to TSF.						
Tailings Pipeline	<ul style="list-style-type: none"> • Free draining, gravity flow pipeline. • Butt fusion welded HDPE with 24" / 30" DR15.5 and 22" DR17. 						
Spigots	<ul style="list-style-type: none"> • Movable discharge section placed on tailings embankment crest. 						
Flow Rate	<ul style="list-style-type: none"> • Design throughput 770 tonnes/hr dry solids. • Slurry solids content 35%. • Design flow 19.6 cfs (0.55m³/s). Increases to 23.8 cfs (0.67m³/s) at 30% solids content with addition of 4.2 cfs storm water runoff. 						
Spill Containment:	<ul style="list-style-type: none"> • Pipeline laid in pipe containment channel. There is an overflow pond for the T2 Drop box. 						
<i>Mill site to Bootjack Creek</i>							
<i>Bootjack Creek Crossing</i>	<ul style="list-style-type: none"> • Pipeline sleeved in pipe containment channel. 						
<i>Bootjack Creek to TSF</i>	<ul style="list-style-type: none"> • Pipeline laid in pipe containment channel. 						

TABLE 3.1

MOUNT POLLEY MINING CORPORATION
MOUNT POLLEY MINE

STAGE 6 DESIGN BASIS AND OPERATING CRITERIA

Print: 18-Jun-07

Revised: 15-May-07

M:\1101\00001\18VA\Report\Tables\Table 3.1.Doc

4.2 Reclaim Water System	
Function	Primary source of water for milling process. (Pump and Barge System Designed by Others.)
Reclaim Barge	<ul style="list-style-type: none"> Prefabricated pump station on barge in excavated channel in TSF. Local and remote control from Millsite.
Reclaim Pipeline	<ul style="list-style-type: none"> 24" pipeline with a steel section at the reclaim barge and HDPE with varying pressure ratings along length.
Reclaim Booster Pump Station	<ul style="list-style-type: none"> Prefabricated pump station located between TSF and Millsite. Identical pumps, sensors and controls at reclaim barge for ease of maintenance.
Spill Containment	<ul style="list-style-type: none"> See Item 4.1 above. Booster pump station has closed sump.
4.3 Seepage Recycle System	
Function	Return seepage and foundation drain flows to TSF.
Drain Monitoring Sumps	Flow quantity and water quality measurements on individual drains.
Seepage Collection Ponds	<ul style="list-style-type: none"> Sized to hold 10 times maximum weekly seepage flow quantity. Excavated in low permeability natural soils, operated as groundwater sink.
Seepage Recycle Pumps	<ul style="list-style-type: none"> Set in vertical pump sumps. Submersible pumps, system by Others. Pumps discharge back to TSF via 150 mm HDPE pipes.
5.0 WATER MANAGEMENT	
5.1 General	
	<ul style="list-style-type: none"> To contain runoff from disturbed project areas when and as required to meet the project Water Management Plan objectives. To divert clean water from the project areas. Permitted discharge volume of 700,000 m³ per year from the ME Seepage recycle pond. Excess water stored in the TSF pond.
5.2 Millsite Sump	
Catchment Area	Approx. 20 ha direct catchment, plus pit dewatering.
Design Storm	1.5 x 1 in 10 yr. 24 hour event runoff (6,000 m ³)
Sump Cross-Section	3:1 inside slope, 2:1 outside slope, 4m crest width.
Normal Operating Level	1102.7 m
Maximum Operating Level	1106.2 m
Flow Control Structures	Reference Report 1627/2, Drawing No. 1625.232.
Discharge Pipe	300 mm HDPE DR 21 to plant or tailings line.
Flow Monitoring	None.
5.3 Southeast Sediment Pond	
Catchment Area	Approx. 150 ha direct catchment.
Design Storm	1 in 10 yr. 24 hour event runoff (25,000 m ³)
Sump Cross-Section	3:1 inside slope, 2:1 outside slope, 4m crest width.
Normal Operating Level	1054.5 m
Maximum Operating Level	1057.4 m
Flow Control Structures	Reference Report 1627/2, Drawing No. 1625.232.
Discharge Pipe	250 mm HDPE DR 21 to Reclaim sump or T2 Dropbox

TABLE 3.1

**MOUNT POLLEY MINING CORPORATION
MOUNT POLLEY MINE**

STAGE 6 DESIGN BASIS AND OPERATING CRITERIA

Print: 18-Jun-07

Revised: 15-May-07

M:\1\01\00001\18\A\Report\Tables\Table 3.1.Doc

Flow Monitoring	None.
INSTRUMENTATION AND MONITORING	
6.1 General	To quantify environmental conditions and performance characteristics of the TSF to ensure compliance with design objectives.
6.2 Geotechnical Instrumentation and Monitoring	
Piezometers	<ul style="list-style-type: none"> • Measure pore pressures in drains, foundations, fill materials and tailings. • Vibrating wire piezometers. • Installed by qualified technical personnel. • Four instrumentation planes for Main Embankment, three for the Perimeter Embankment, and two for the South Embankment. • 56 piezometers installed to date. Additional piezometers to be installed in Stage 6 to provide redundancy (as per the Dam Safety Review). • Foundation piezometers at the Main Embankment have a trigger level set at 6 m above ground surface due to artesian condition in this area.
Survey Monuments	<ul style="list-style-type: none"> • Deformation and settlement monitoring of embankments.
Inclinometers	<ul style="list-style-type: none"> • Measure potential deformation of the embankment materials. • Installed by qualified technical personnel. • Five slope inclinometers installed at the toe of the Main Embankment. Four are still functional.
6.3 Flow Monitoring	<ul style="list-style-type: none"> • To provide data for on-going water balance calculations. • Drain flows regularly monitored. • Reclaim and seepage pump systems flow meters. • Tailings output monitored at millsite. • Stream flow monitoring.
6.4 Operational Monitoring	<ul style="list-style-type: none"> • As per the OM&S Manual.
CLOSURE REQUIREMENTS	
7.1 General	<ul style="list-style-type: none"> • Return impoundment to equivalent pre-mining use and productivity by establishing a wetland area adjacent to a final spillway and re-vegetating remainder of tailings surface with indigenous species of trees, shrubs and grasses adjacent to embankment grading to aquatic species along and adjacent to final pond. • Concurrent reclamation of the final downstream embankment slopes. • Wetlands treatment system to treat routed water from the TSF prior to discharge to environment.
7.2 Spillway	<ul style="list-style-type: none"> • Two stage spillway with lower channel outlet designed to pass 1 in 200 yr. 24 hour flood event and upper wider outlet section designed to pass PMF without overtopping embankments.

TABLE 3.1

MOUNT POLLEY MINING CORPORATION
MOUNT POLLEY MINE

STAGE 6 DESIGN BASIS AND OPERATING CRITERIA

M:\1\01\00001\18\A\Report\Tables\Table 3.1.Doc

Print: 18-Jun-07
Revised: 15-May-07

	<p>Designed to consider protection against beaver dams.</p> <ul style="list-style-type: none">• Spillway to be located on the Northeast corner of the TSF on the Perimeter Embankment.
--	------------------------------------------------------------------------------------------------------------------------------------------------------------------------------------------------------

Notes:

1. The closure plan will remain flexible during operations to allow for future changes in the mine plan and to incorporate information from on-going reclamation programs.

Rev 0 – Issued for Report

TABLE 3.2

MOUNT POLLEY MINING CORPORATION
MOUNT POLLEY MINE

EMBANKMENT MATERIAL QUANTITIES ESTIMATE

M:\11010000\118\A\Report\1 - Tables\Table 3.2.xls\Summary

Rev'd Jun/15/07

ZONE	Stage									Net Total
	6a	6b	7a	7b	8a	8b	9			
U	392,000	229,000	252,000	194,000	159,000	90,000	142,000			1,458,000
S	96,000	63,000	42,000	63,000	42,000	42,000	63,000			411,000
F	20,000	15,000	10,000	15,000	10,000	10,000	15,000			95,000
T	20,000	15,000	10,000	15,000	10,000	10,000	15,000			95,000
C	302,000	165,000	81,000	98,000	49,000	35,000	25,000			755,000
C BUTTRESS	140,000		-	-	-	-	350,000			490,000

Notes:

- 1.) Volumes are calculated in cubic meters
- 2.) Volumes are based on neat line quantities

Rev 0 - Issued for Report

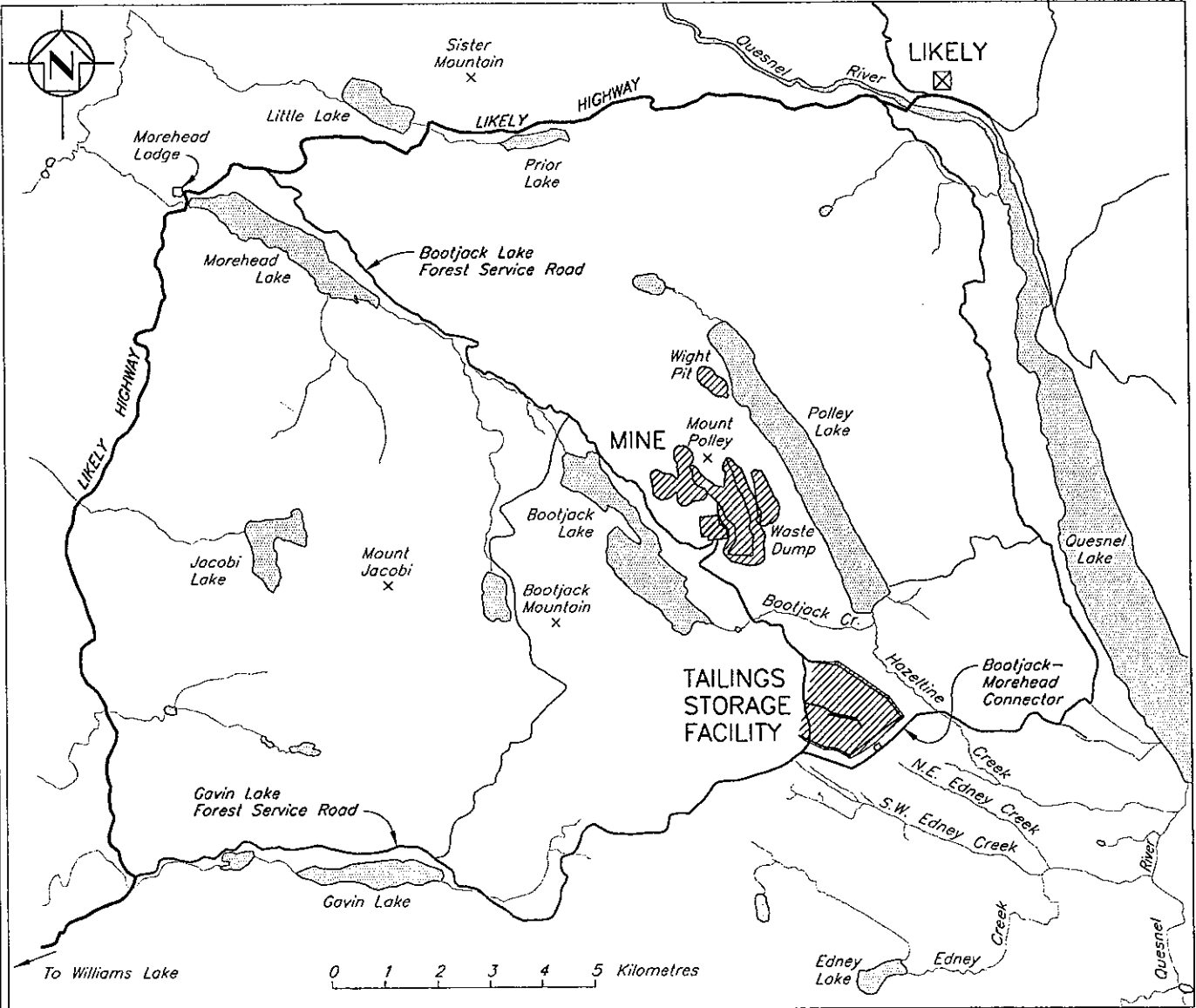

LOCATION MAP

MOUNT POLLEY MINING CORPORATION			
MOUNT POLLEY MINE			
PROJECT LOCATION AND ACCESS PLAN			
<i>Knight Piésold</i> CONSULTING	PROJECT/ASSIGNMENT NO.	REF. NO.	REV.
	VA101-1/18	1	0
FIGURE 1.1			

REV. 0 08JUN'07 ISSUED FOR STAGE 6 PERMITTING

Vancouver B.C. CAD FILE: M:\1\0\06001\18\VA\head\Fig1\401.DWG 1-125000 PLOT: 1=(P) Jun 08 2007 by:jgms Time: 16:11



Notes:

1) Photograph taken in October 2005

MOUNT POLLEY MINING CORPORATION		
MOUNT POLLEY MINE		
AERIAL PHOTOGRAPH OF MOUNT POLLEY MINE VIEWING NORTH		
<i>Knight Piésold</i> CONSULTING	PROJECT / ASSIGNMENT NO. VA 101-1/18	REF NO. 1
	FIGURE 1.2	
		REV. 0



Notes:

1) Photograph taken in October 2005

MOUNT POLLEY MINING CORPORATION		
MOUNT POLLEY MINE		
AERIAL PHOTOGRAPH OF MOUNT POLLEY MINE VIEWING SOUTH		
<i>Knight Piésold</i> CONSULTING	PROJECT / ASSIGNMENT NO. VA 101-1/18	REF NO. 1
	FIGURE 1.3	
		REV. 0

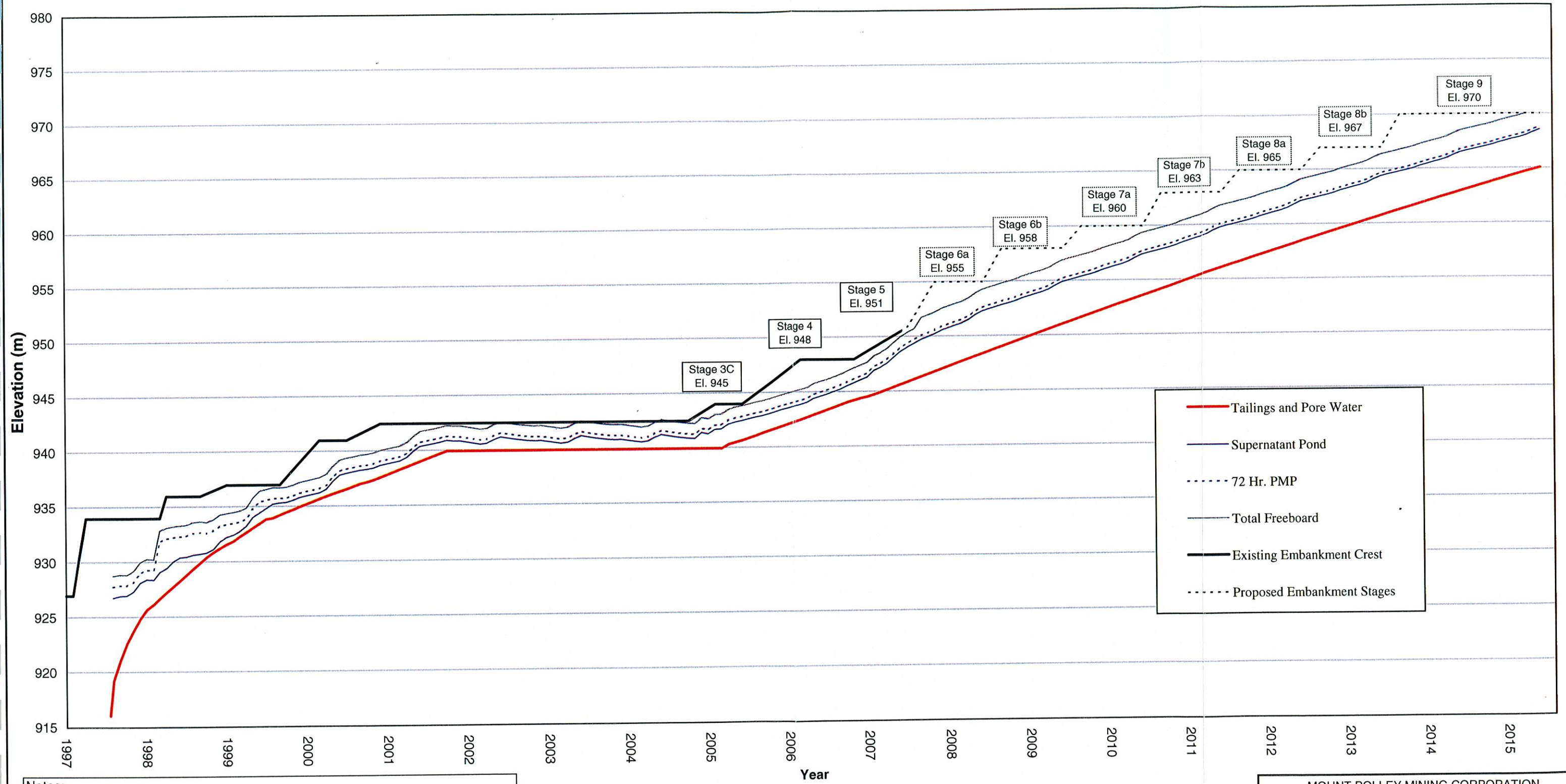

Notes:

1. Based on a production rate of 20,000 tpd .
2. Projected bulk tailings dry density is 1.4 t/m³ for tailings reporting to the TSF after August 2000.
3. The filling schedule will be updated as required to reflect actual mine throughput and the supernatant pond volume.

Rev 0 - Issued for Report

MOUNT POLLEY MINING CORPORATION		
MOUNT POLLEY MINE		
TAILINGS STORAGE FACILITY FILLING SCHEDULE		
<i>Knight Piésold</i> CONSULTING	PROJECT NO.	REF. NO.
	VA 101-1/18	1
		REV. 0
FIGURE 3.1		

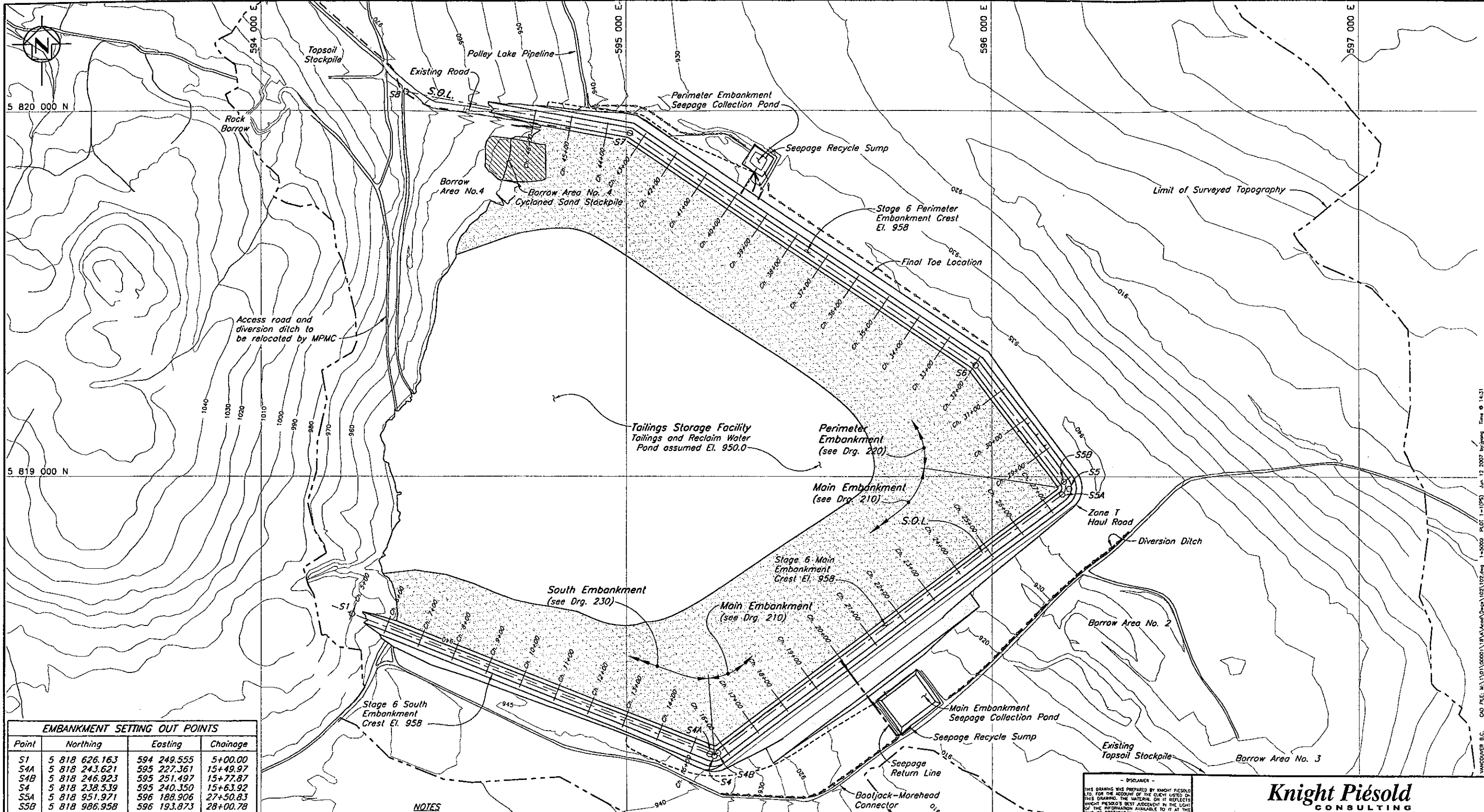

EMBANKMENT SETTING OUT POINTS			
Point	Northing	Easting	Chainage
S1	5 818 626.163	594 249.555	5+00.00
S4A	5 818 243.621	595 227.361	15+49.97
S4B	5 818 246.923	595 251.497	15+77.87
S4	5 818 238.539	595 240.350	15+63.92
S5A	5 818 951.971	596 188.906	27+50.83
S5B	5 818 986.958	596 193.873	28+00.78
S5	5 818 966.983	596 208.866	27+75.80
S6	5 819 304.035	595 955.881	31+97.23
S7	5 819 939.748	595 010.249	43+36.69
S8	5 820 053.034	594 396.471	49+60.83

- NOTES**
1. Topography at TSF generated from points and break lines sent from MPMC in July 1999. The topography outside the TSF area is from 1997 flyover. UTM, NAD83, Zone 10.
 2. Stage 6 crest El. 958.0.

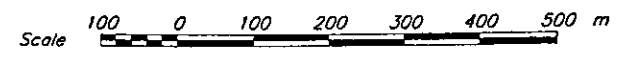

NOT FOR CONSTRUCTION

DRG. NO.	DESCRIPTION	REV.	DATE	DESCRIPTION	DESIGN	DRAWN	CHK'D	APP'D
220	T.S.F. - STAGE 6 PERIMETER EMBANKMENT - PLAN							
210	T.S.F. - STAGE 6 MAIN EMBANKMENT - PLAN							
230	T.S.F. - STAGE 6 SOUTH EMBANKMENT - PLAN AND SECTION							

REV.	DATE	DESCRIPTION	DESIGN	DRAWN	CHK'D	APP'D
0	08/JUN/07	ISSUED FOR STAGE 6 PERMITTING				

REV.	DATE	DESCRIPTION	DESIGN	DRAWN	CHK'D	APP'D
0	08/JUN/07	ISSUED FOR STAGE 6 PERMITTING				

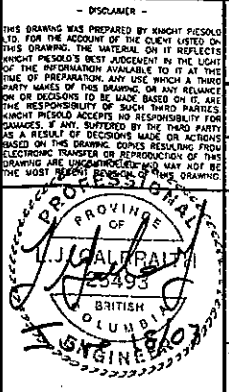

Knights Piesold
CONSULTING

MOUNT POLLEY MINING CORPORATION

MOUNT POLLEY MINE

TAILINGS STORAGE FACILITY
STAGE 6 TAILINGS EMBANKMENT
GENERAL ARRANGEMENT

PROJECT/ASSIGNMENT NO.	DRAWING NO.	REVISION
VA101-1/18	102	0

XREF FILE : TOP099, Stage6_Plan

CAD FILE: M:\1\01\00001\18\VA\Stage6\Draws\102\102.dwg 1-5000 PLOT 1-1 (EPS) Jun 12 2007 by: jmg Time: 0:14:31

UNIFIED SOIL CLASSIFICATION SYSTEM

ZONE S

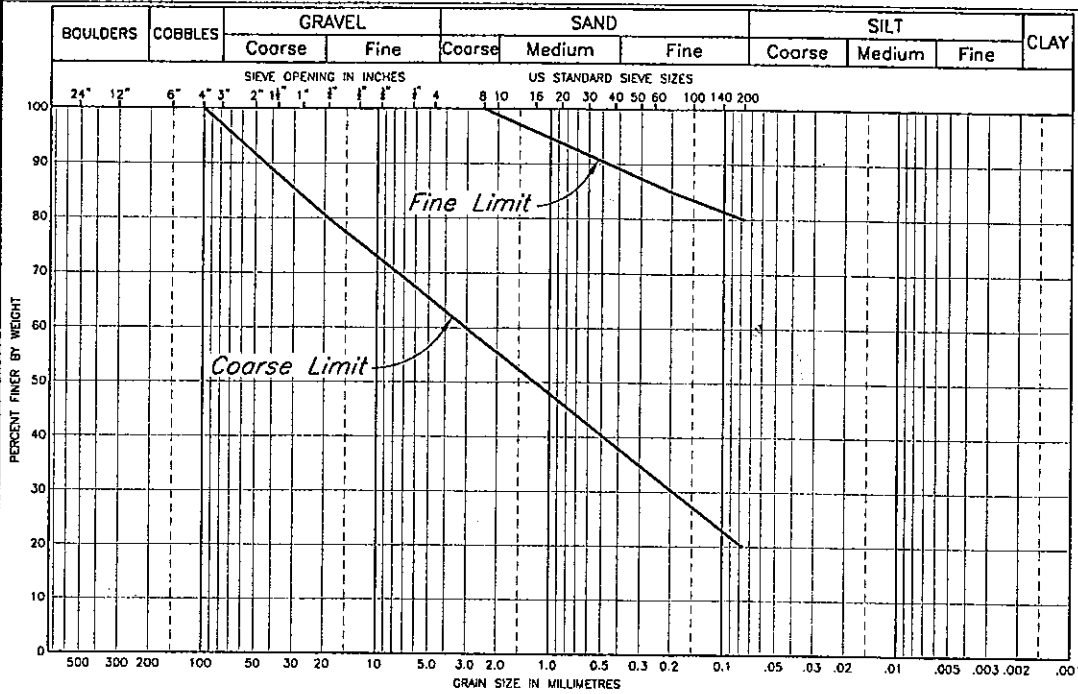

UNIFIED SOIL CLASSIFICATION SYSTEM

ZONE T and ZONE C

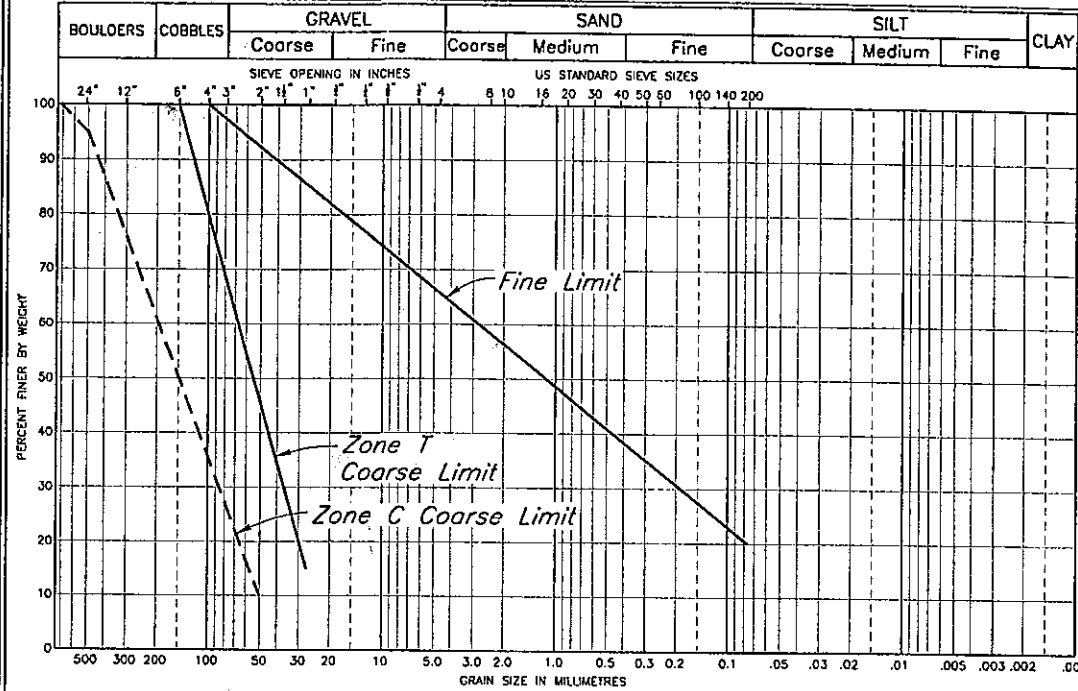

ZONE	MATERIAL TYPE	LOCATION	PLACEMENT & COMPACTION REQUIREMENTS
S	Glacial till	Core Zone	Placed, moisture conditioned and spread in maximum 300 mm thick layers (after compaction). Vibratory compaction to 95% of Standard Proctor maximum dry density or as approved by the Engineer.
	Rock	Shell Zone	Placed and spread in maximum 2000 mm thick layers and compacted by selective routing of mine haul trucks.
T	Rock	Transition Zone/ Confining Berm	Placed and spread in maximum 600 mm thick layers and compacted with minimum 4 passes of 10 ton smooth drum vibratory roller, or as approved by the Engineer.
F	Filter sand	Chimney Drain	Placed and spread in maximum 600 mm thick layers and compacted with minimum 4 passes of 10 ton smooth drum vibratory roller, or as approved by the Engineer.
FT	Sand	Downstream Foundation	Placed and spread in maximum 300 mm thick layers and compacted with minimum 4 passes of 10 ton smooth drum vibratory roller, or as approved by the Engineer.
	Select Fill	Upstream Toe	Placement and compaction requirements to be determined based on material selection.
	Select Coarse Rockfill	Upstream Toe	Placed to establish a firm foundation for subsequent fill placement.
	Drainage Gravel	Drains	Placed around drainage pipes and wrapped with geotextile.

UNIFIED SOIL CLASSIFICATION SYSTEM

ZONE F AND ZONE FT

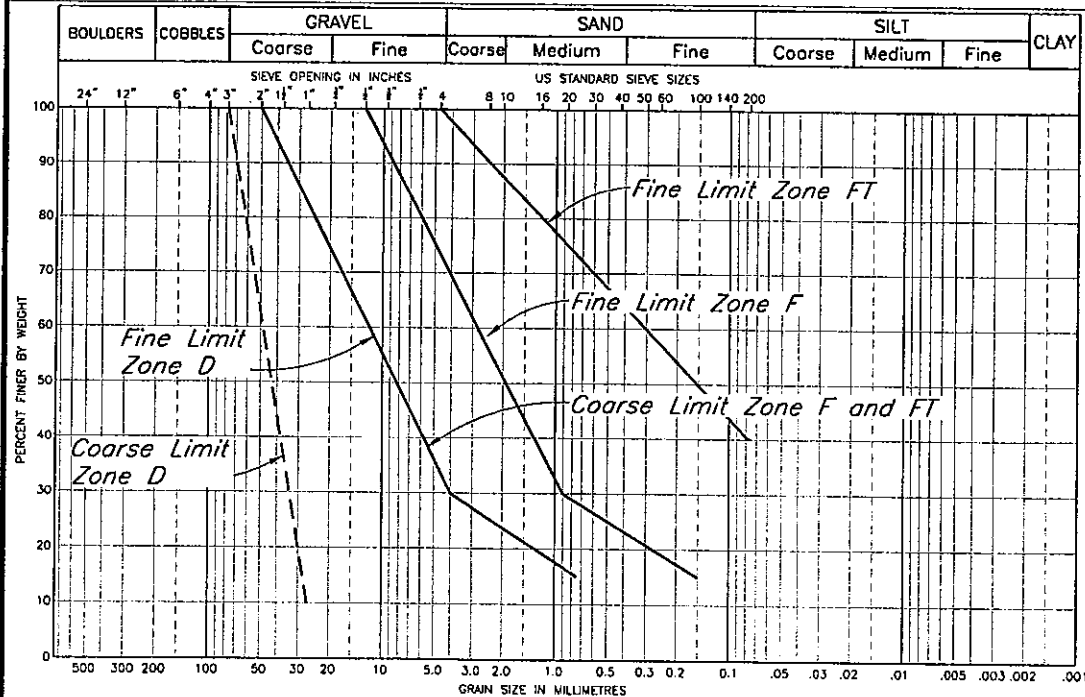

UNIFIED SOIL CLASSIFICATION SYSTEM

ZONE U

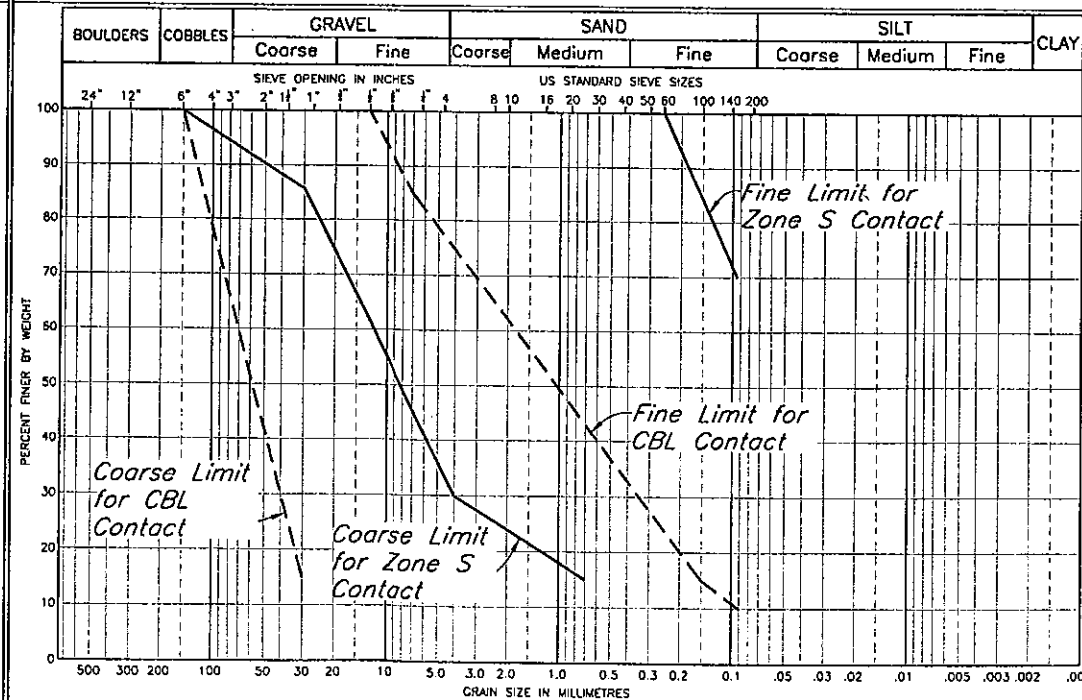

NOT FOR CONSTRUCTION

DISCLAIMER
THIS DRAWING WAS PREPARED BY KNIGHT PIESOLD LTD. FOR THE ACCOUNT OF THE CLIENT LISTED ON THIS DRAWING. THE MATERIAL ON IT REFLECTS KNIGHT PIESOLD'S BEST JUDGMENT IN THE LIGHT OF THE INFORMATION AVAILABLE TO IT AT THE TIME OF PREPARATION. ANY USE WHICH A THIRD PARTY MAKES OF THIS DRAWING OR ANY RELIANCE ON OR DECISIONS TO BE MADE BASED ON IT, ARE THE RESPONSIBILITY OF SUCH THIRD PARTY. KNIGHT PIESOLD ACCEPTS NO RESPONSIBILITY FOR DAMAGES, IF ANY, SUFFERED BY THE THIRD PARTY AS A RESULT OF DECISIONS MADE OR ACTIONS TAKEN AS A RESULT OF THIS DRAWING. COPIES RESULTING FROM ELECTRONIC TRANSFER OR REPRODUCTION OF THIS DRAWING ARE UNCONTROLLED AND MAY NOT BE THE MOST RECENT VERSION OF THIS DRAWING.

Knicht Piesold
CONSULTING

MOUNT POLLEY MINING CORPORATION

MOUNT POLLEY MINE

TAILINGS STORAGE FACILITY
STAGE 6 TAILINGS EMBANKMENT
MATERIAL SPECIFICATIONS

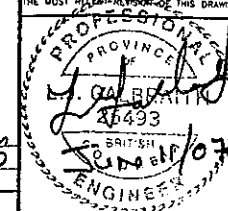

235	STAGE 6 SOUTH EMBANKMENT - SECTIONS
225/226	STAGE 6 - PERIMETER EMBANKMENT - SECTIONS AND DETAILS
215/216	STAGE 6 - MAIN EMBANKMENT - SECTIONS AND DETAILS
240	STAGE 6 UPSTREAM TOE DRAIN - SECTIONS AND DETAILS
DRG. NO.	DESCRIPTION

REV.	DATE	DESCRIPTION

DESIGN	DRAWN	CHK'D	APP'D

REV.	DATE	DESCRIPTION	DESIGN	DRAWN	CHK'D	APP'D
0	08/JUN/07	ISSUED FOR STAGE 6 PERMITTING	LWG	JY	BB	KLS

PROJECT/ASSIGNMENT NO.	DRAWING NO.	REVISION
VA1010-1/18	104	0

VANCOUVER B.C. CAD FILE: M:\A1\00001\18\VA1010-1\18.dwg 1:1 PLOT 1:1 (P2) Jun 08 2007 07:50:00 Time: 0:16:23

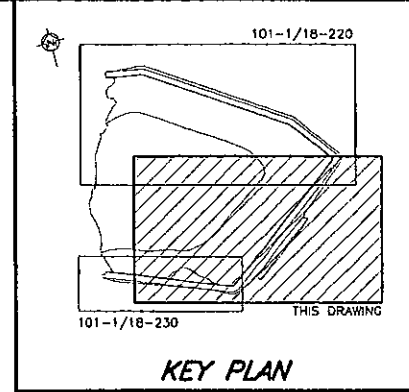
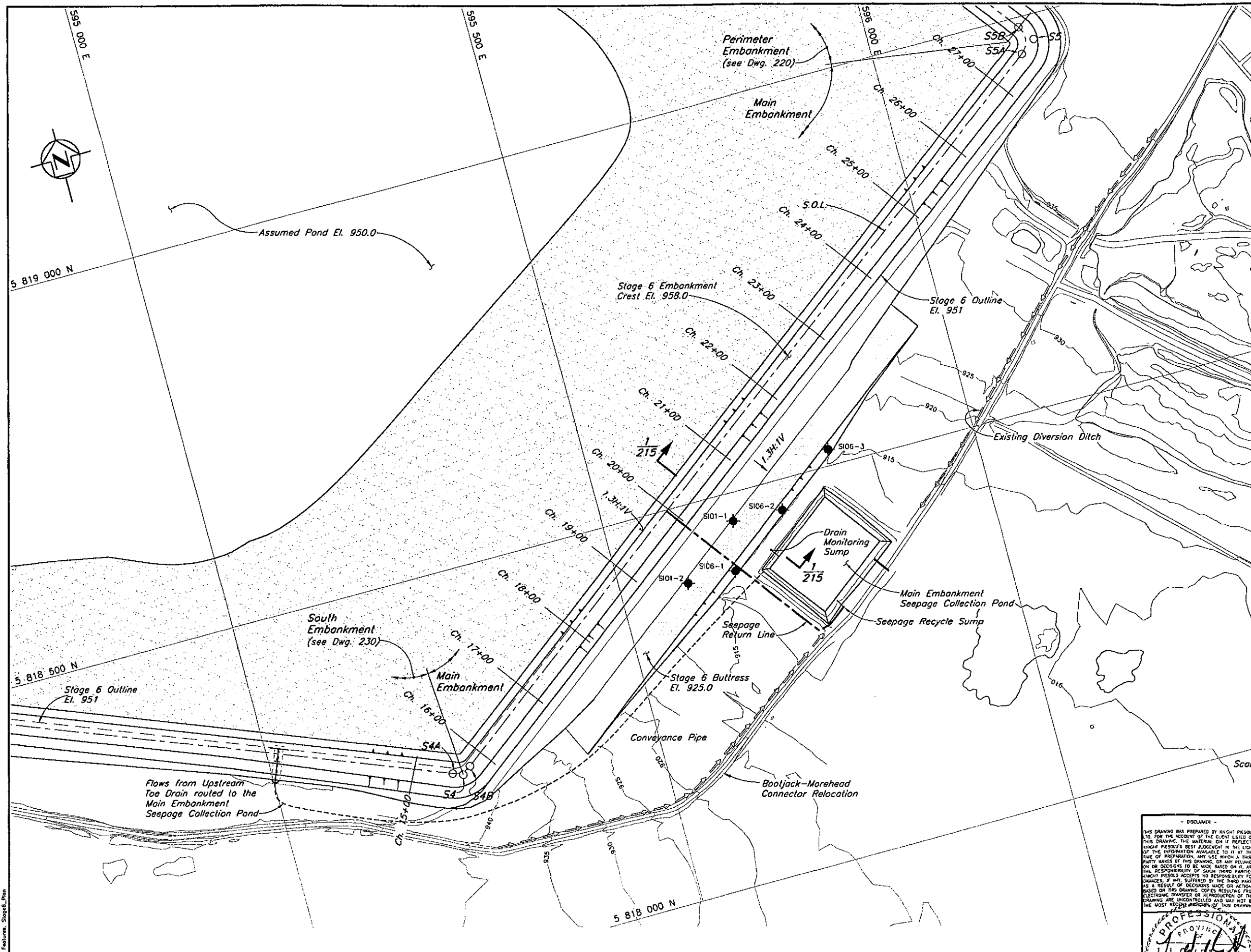

LEGEND
 S101-3 Existing Inclinometer

NOTES
 1. Topography from 2004 flyover
 2. All dimensions in millimetres and elevations in metres, unless noted otherwise.

Scale 0 50 100 150 200 250 m

NOT FOR CONSTRUCTION

DISCLAIMER
 THIS DRAWING WAS PREPARED BY KNIGHT PIESOLD & CO. FOR THE ACCOUNT OF THE CLIENT LISTED ON THIS DRAWING. THE MATERIAL ON IT REFLECTS KNIGHT PIESOLD'S BEST JUDGEMENT IN THE LIGHT OF THE INFORMATION AVAILABLE TO IT AT THE TIME OF PREPARATION. ANY USE WHICH A THIRD PARTY MAKES OF THIS DRAWING OR ANY RELIANCE ON OR DECISIONS TO BE MADE BASED ON IT, ARE THE RESPONSIBILITY OF SUCH THIRD PARTIES. KNIGHT PIESOLD ACCEPTS NO RESPONSIBILITY FOR DAMAGES, IF ANY, SUFFERED BY THE THIRD PARTY AS A RESULT OF DECISIONS MADE OR ACTIONS TAKEN ON THIS DRAWING. COPIES REPRODUCED BY ELECTRONIC TRANSFER OR REPRODUCTION OF THIS DRAWING ARE UNCONTROLLED AND MAY NOT BE THE MOST RECENT EDITION OF THIS DRAWING.

PROFESSIONAL ENGINEER
 L.J. [Signature]
 35493
 BRITISH COLUMBIA

Knicht Piésold CONSULTING

MOUNT POLLEY MINING CORPORATION

MOUNT POLLEY MINE

TAILINGS STORAGE FACILITY
 STAGE 6 MAIN EMBANKMENT PLAN

PROJECT/ASSIGNMENT NO. VA101-1/18 DRAWING NO. 210 REVISION 0

DRG. NO.	DESCRIPTION	REV.	DATE	DESCRIPTION	DESIGN	DRAWN	CHK'D	APP'D			
230	STAGE 6 SOUTH EMBANKMENT - PLAN										
220	STAGE 6 PERIMETER EMBANKMENT - PLAN										
215	STAGE 6 MAIN EMBANKMENT - SECTIONS AND DETAILS										
REFERENCE DRAWINGS				REVISIONS				REVISIONS			

REV.	DATE	DESCRIPTION	DESIGN	DRAWN	CHK'D	APP'D
0	08JUN'07	ISSUED FOR STAGE 6 PERMITTING	LJG	JY	BB	KIG

XREF FILE: T:\topo\2004_Features_Stage6_Plan

W:\COURIER.B.C. CAD FILE: M:\101\0004\18\VA101-1\18-220.dwg 1=2500 PLOT: 1=1/8" Jun 12 2007 10:45:00 Time: 0 4:31

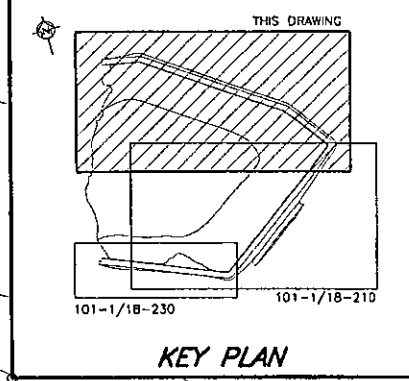
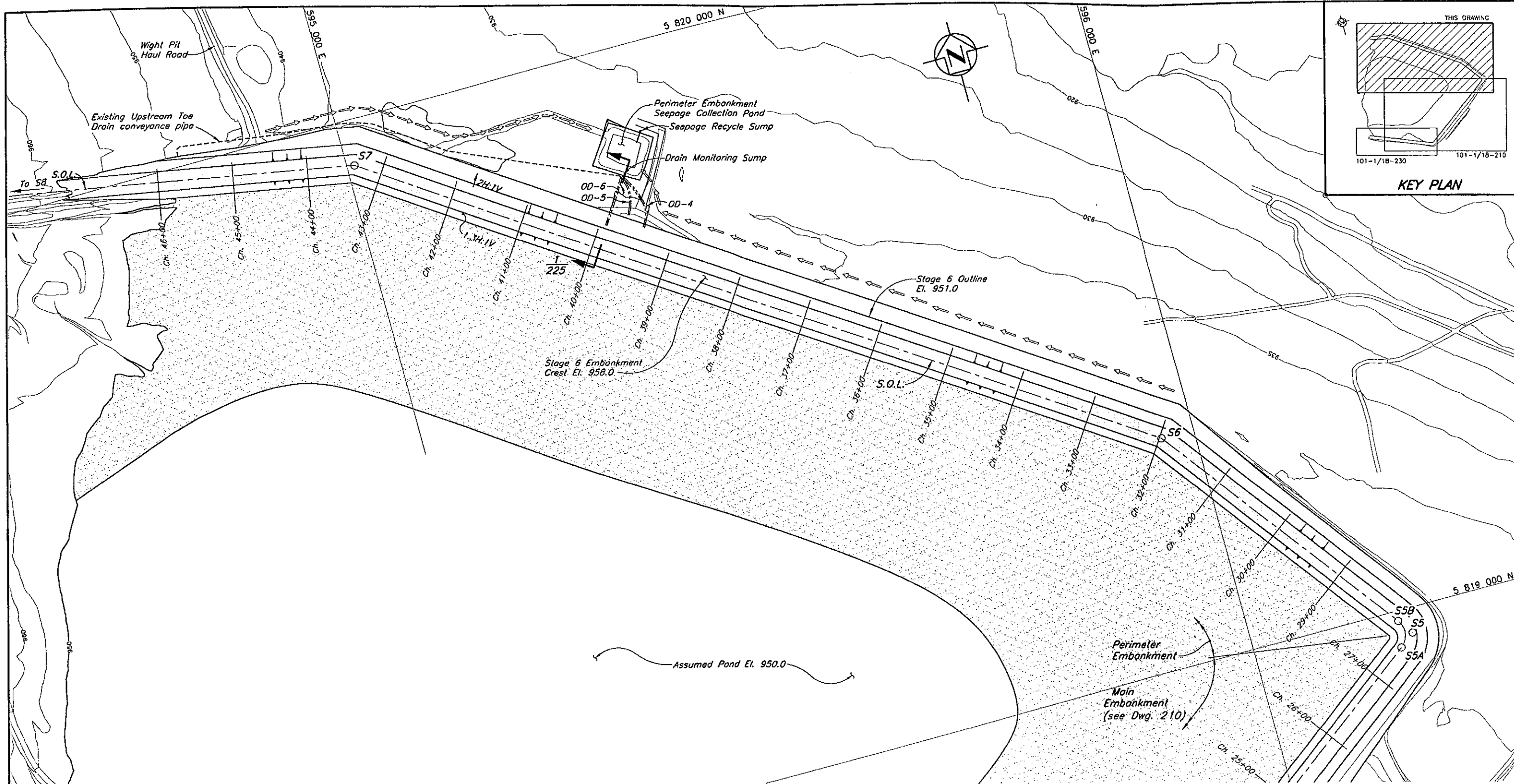

EMBANKMENT SETTING OUT POINTS			
Point	Northing	Easting	Chainage
S1	5 818 626.163	594 249.555	5+00.00
S4A	5 818 243.621	595 227.361	15+49.97
S4B	5 818 246.923	595 251.497	15+77.87
S4	5 818 238.539	595 240.350	15+63.92
S5A	5 818 951.971	596 188.906	27+50.83
S5B	5 818 986.958	596 193.873	28+00.78
S5	5 818 966.983	596 208.866	27+75.80
S6	5 819 304.035	595 955.881	31+97.23
S7	5 819 939.748	595 010.249	43+36.69
S8	5 820 053.034	594 396.471	49+60.83

- NOTES**
1. Topography from 2004 flyover.
 2. All dimensions in millimetres and elevations in metres, unless noted otherwise.

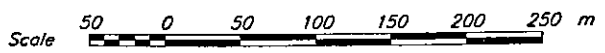

NOT FOR CONSTRUCTION

DISCLAIMER

THIS DRAWING WAS PREPARED BY KNIGHT PIESOLD LTD. FOR THE ACCOUNT OF THE CLIENT LISTED ON THIS DRAWING. THE MATERIAL ON IT REFLECTS KNIGHT PIESOLD'S BEST JUDGEMENT IN THE LIGHT OF THE INFORMATION AVAILABLE TO IT AT THE TIME OF PREPARATION. ANY USE WHICH A THIRD PARTY MAKES OF THIS DRAWING, OR ANY RELIANCE ON OR DECISIONS TO BE MADE BASED ON IT, ARE THE RESPONSIBILITY OF SUCH THIRD PARTIES. KNIGHT PIESOLD ACCEPTS NO RESPONSIBILITY FOR DAMAGES, IF ANY, SUFFERED BY THE THIRD PARTY AS A RESULT OF DECISIONS MADE OR ACTIONS TAKEN ON THIS DRAWING. COPIES REPRODUCED FROM ELECTRONIC TRANSFER OR REPRODUCTION OF THIS DRAWING ARE UNCONTROLLED AND MAY NOT BE THE MOST RECENT VERSION OF THIS DRAWING.

PROFESSIONAL ENGINEER
 J. J. GIBLIN
 5493
 BRITISH Columbia
 1997

Knights Piesold CONSULTING

MOUNT POLLEY MINING CORPORATION

MOUNT POLLEY MINE

TAILINGS STORAGE FACILITY
STAGE 6 PERIMETER EMBANKMENT PLAN

PROJECT/ASSIGNMENT NO. **VA101-1/18** DRAWING NO. **220** REVISION **0**

REF. NO.	DESCRIPTION
240	STAGE 6 PERIMETER EMBANKMENT - UPSTREAM TOE DRAIN
230	STAGE 6 SOUTH EMBANKMENT - PLAN
225	STAGE 6 PERIMETER EMBANKMENT - SECTIONS
210	STAGE 6 MAIN EMBANKMENT - PLAN

REV.	DATE	DESCRIPTION	DESIGN	DRAWN	CHK'D	APP'D

REV.	DATE	DESCRIPTION	DESIGN	DRAWN	CHK'D	APP'D
0	08JUN'07	ISSUED FOR STAGE 6 PERMITTING	LJG	JY	BS	KBS

REF FILE: Tens2004_Features

CAD FILE: K:\1\100001\TVA\Acad\Drawn\220.dwg 1:2500 PLOT 1-1(PES) Jun 08 2007 10:49:16 AM © 15:49 WANDERER, B.C.

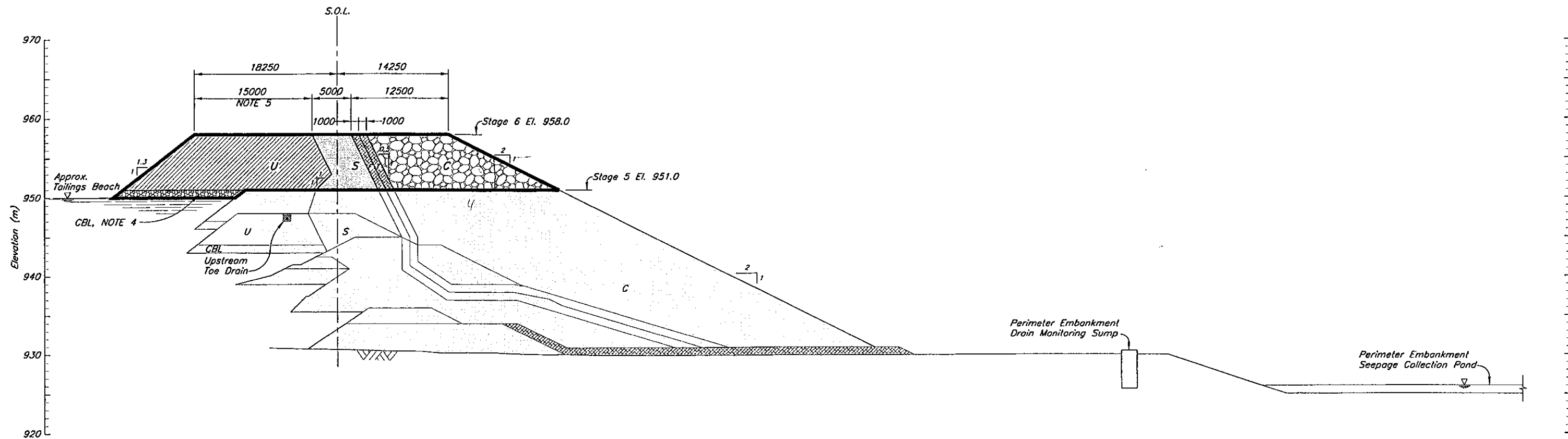

SECTION $\frac{1}{220}$

NOTES

1. For zone material specifications and legend see Drg. 104.
2. All dimensions in millimetres and elevations in metres, unless noted otherwise.
3. Minimum lines and grades shown. Lines and grades may be extended upstream and downstream during Stage 6 construction.
4. Coarse bearing layer may be required on tailings beach adjacent to the embankment to create a competent surface for placement of the Zone U material.
5. The width of the Zone U assumes sand cell construction using Tailings sand.
6. Zone S have a minimum 5 m width above elevation 951.
7. Appropriate filter relationships required between all embankment zones and materials as required by the Engineer.



NOT FOR CONSTRUCTION

DISCLAIMER
THIS DRAWING WAS PREPARED BY KNIGHT PIESOLD LTD. FOR THE ACCOUNT OF THE CLIENT LISTED ON THIS DRAWING. THE MATERIAL ON IT REFLECTS KNIGHT PIESOLD'S BEST JUDGEMENT IN THE LIGHT OF THE INFORMATION AVAILABLE TO IT AT THE TIME OF PREPARATION. ANY USE WHICH A THIRD PARTY MAKES OF THIS DRAWING OR ANY RELIANCE ON OR DECISIONS TO BE MADE BASED ON IT, ARE THE RESPONSIBILITY OF SUCH THIRD PARTIES. KNIGHT PIESOLD ACCEPTS NO RESPONSIBILITY FOR DAMAGES, IF ANY, SUFFERED BY THE THIRD PARTY AS A RESULT OF DECISIONS MADE OR ACTIONS BASED ON THIS DRAWING. COPIES RESULTING FROM ELECTRONIC TRANSFER OR REPRODUCTION OF THIS DRAWING ARE UNCONTROLLED AND MAY NOT BE THE MOST RECENT VERSION OF THIS DRAWING.

Knight Piesold
CONSULTING

MOUNT POLLEY MINING CORPORATION

MOUNT POLLEY MINE

TAILINGS STORAGE FACILITY
STAGE 6 - PERIMETER EMBANKMENT
SECTION

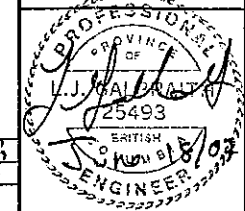

226	STAGE 6 - PERIMETER EMBANKMENT - DETAIL
220	STAGE 6 - PERIMETER EMBANKMENT - PLAN
104	STAGE 6 - MATERIAL SPECIFICATIONS

DRG. NO.	DESCRIPTION	REV.	DATE
REFERENCE DRAWINGS			

DESIGN	DRAWN	CHK'D	APP'D
REVISIONS			

REV.	DATE	DESCRIPTION	DESIGN	DRAWN	CHK'D	APP'D
0	08JUN'07	ISSUED FOR STAGE 6 PERMITTING	LJG	JY	BB	ELG
REVISIONS						

PROJECT/ASSIGNMENT NO.	DRAWING NO.	REVISION
VA101-1/18	225	0

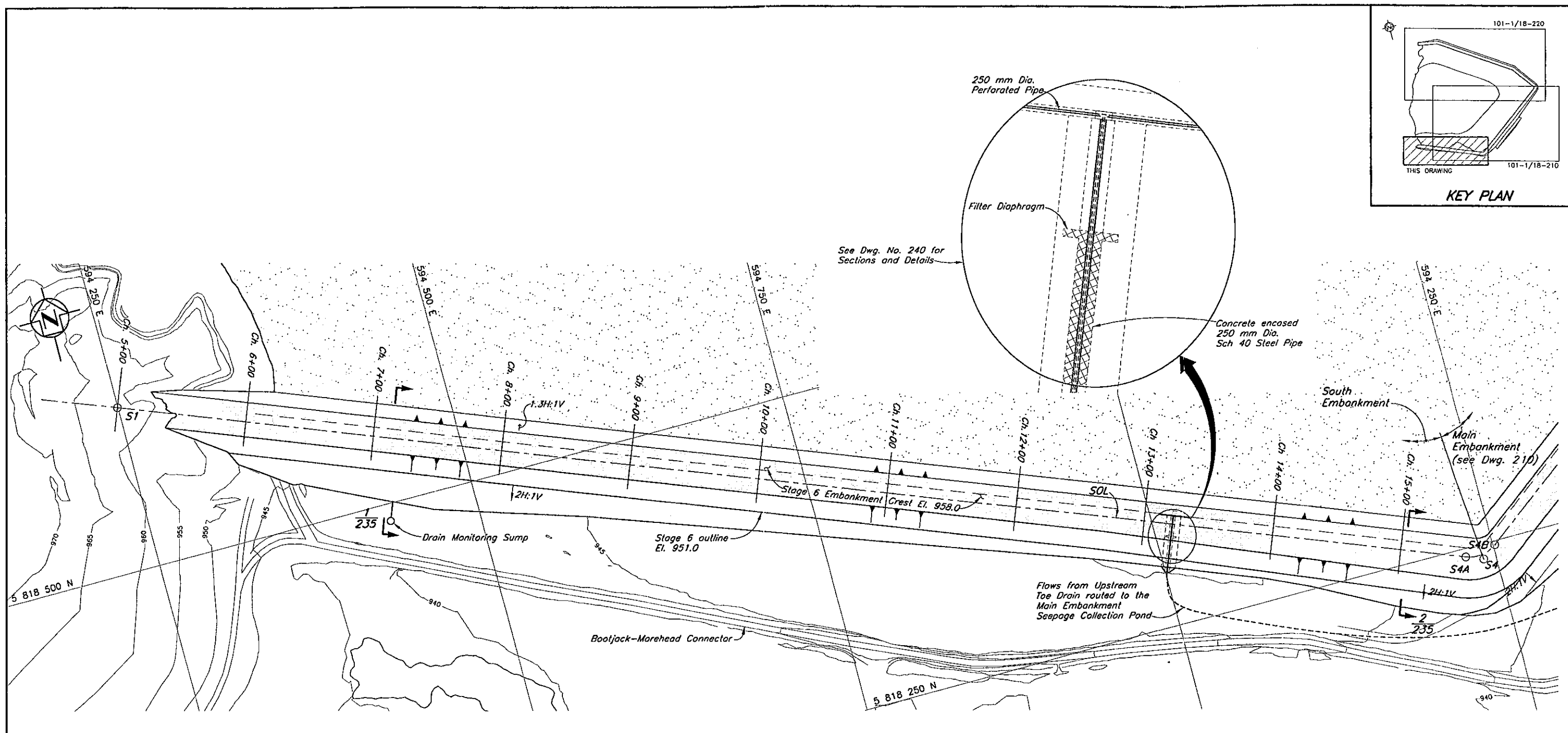
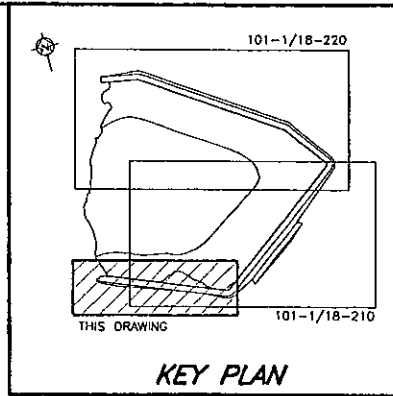

PLAN

NOT FOR CONSTRUCTION

- NOTES**
1. Topography from 2004 flyover.
 2. All dimensions in millimetres and elevations in metres, unless noted otherwise.

DISCLAIMER

THIS DRAWING WAS PREPARED BY KNIGHT PIÉSOLD LTD. FOR THE ACCOUNT OF THE CLIENT LISTED ON THIS DRAWING. THE MATERIAL ON IT REFLECTS KNIGHT PIÉSOLD'S BEST JUDGEMENT IN THE LIGHT OF THE INFORMATION AVAILABLE TO IT AT THE TIME OF PREPARATION AND DOES NOT CONSTITUTE A GUARANTEE OF ACCURACY. ANY RECIPIENT PARTY MAKES OF THIS DRAWING OR ANY RECIPIENT OR BECOMES TO BE MADE BASED ON IT, AND THE RESPONSIBILITY OF SUCH THIRD PARTIES KNIGHT PIÉSOLD ACCEPTS NO RESPONSIBILITY FOR DAMAGES, IF ANY, SUFFERED BY THE THIRD PARTY AS A RESULT OF DECISIONS MADE OR ACTIONS BASED ON THIS DRAWING. COPIES RESULTING FROM ELECTRONIC TRANSFER OR REPRODUCTION OF THIS DRAWING ARE UNCONTROLLED AND MAY NOT BE THE MOST RECENT REVISION OF THIS DRAWING.

PROFESSIONAL ENGINEER
J. M. GILBERT
85493
JUN 18 2007

Knights Piésold CONSULTING

MOUNT POLLEY MINE CORPORATION

MOUNT POLLEY MINE

TAILINGS STORAGE FACILITY
STAGE 6 SOUTH EMBANKMENT
PLAN

PROJECT/ASSIGNMENT NO. **VA101-1/18** DRAWING NO. **230** REVISION **0**

235	STAGE 6 SOUTH EMBANKMENT - SECTIONS
220	STAGE 6 PERIMETER EMBANKMENT - PLAN
210	STAGE 6 MAIN EMBANKMENT - PLAN
104	STAGE 6 TAILINGS EMBANKMENT - MATERIAL SPECIFICATIONS
DRG. NO.	DESCRIPTION
REFERENCE DRAWINGS	

REV.	DATE	DESCRIPTION	DESIGN	DRAWN	CHK'D	APP'D
0	08JUN'07	ISSUED FOR STAGE 6 PERMITTING	LJG	JY	SS	AD
REVISIONS						

C:\P\101\101\000001\18\VA101\Drawn\Stage\230\230.dwg 1=1500 PLOT 1=1(P) Jun 12 2007 10:30:30 AM Time 0 14:22
 VANCOUVER B.C.

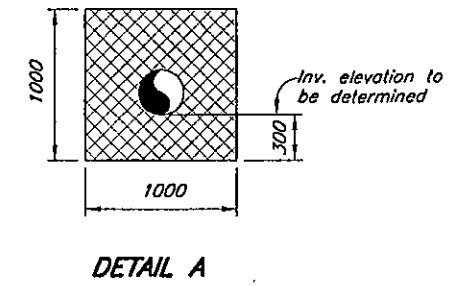
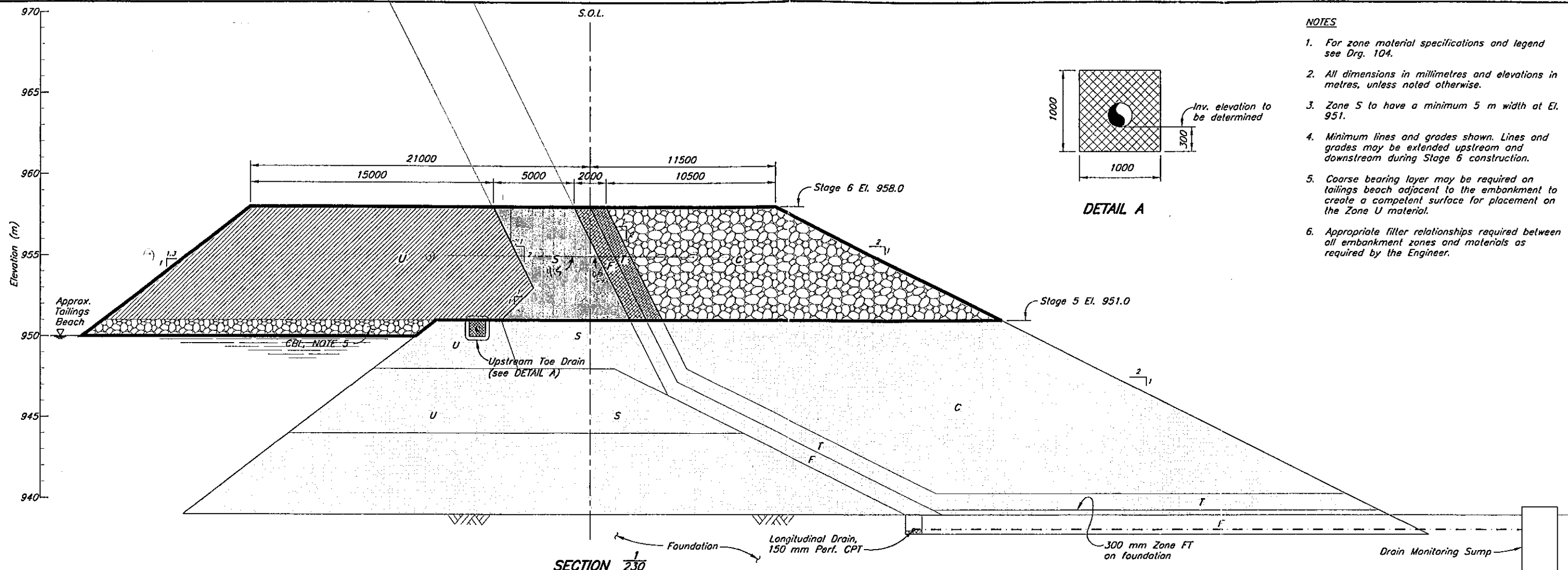

- NOTES**
1. For zone material specifications and legend see Drg. 104.
 2. All dimensions in millimetres and elevations in metres, unless noted otherwise.
 3. Zone S to have a minimum 5 m width at El. 951.
 4. Minimum lines and grades shown. Lines and grades may be extended upstream and downstream during Stage 6 construction.
 5. Coarse bearing layer may be required on tailings beach adjacent to the embankment to create a competent surface for placement on the Zone U material.
 6. Appropriate filter relationships required between all embankment zones and materials as required by the Engineer.

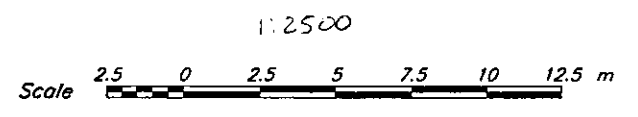
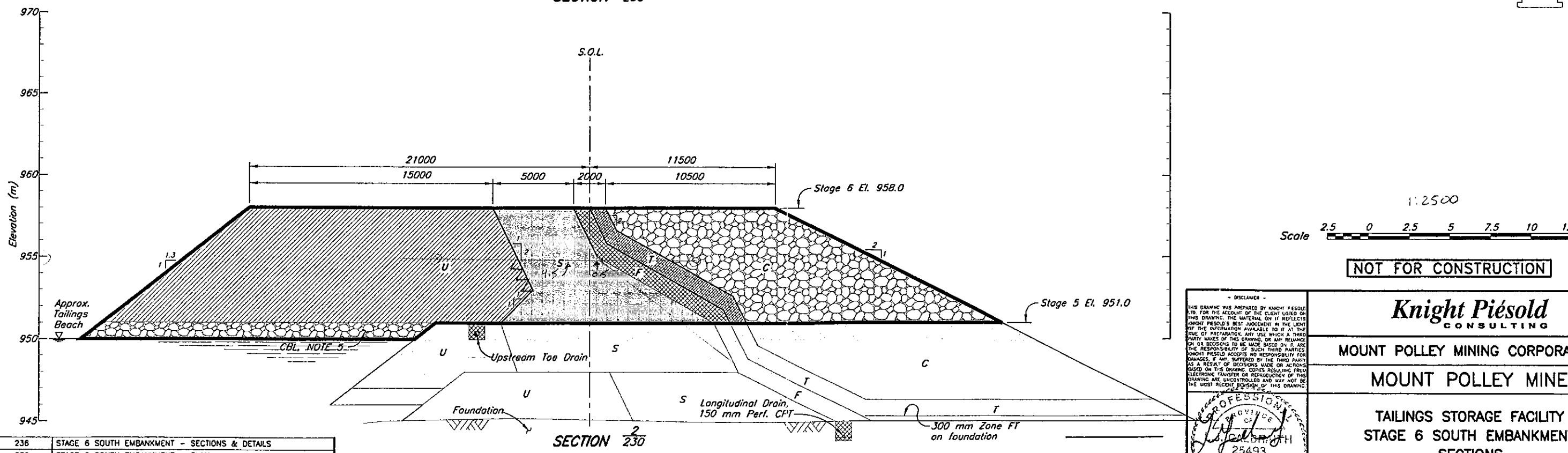

NOT FOR CONSTRUCTION

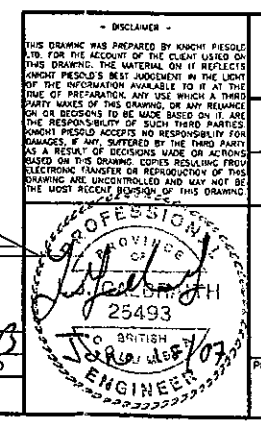

Knicht Piésold CONSULTING

MOUNT POLLEY MINING CORPORATION

MOUNT POLLEY MINE

TAILINGS STORAGE FACILITY
STAGE 6 SOUTH EMBANKMENT
SECTIONS

PROJECT/ASSIGNMENT NO. **VA101-1/18** DRAWING NO. **235** REVISION **0**

DRG. NO.	DESCRIPTION	REV.	DATE	DESCRIPTION	DESIGN	DRAWN	CHK'D	APP'D			
236	STAGE 6 SOUTH EMBANKMENT - SECTIONS & DETAILS										
230	STAGE 6 SOUTH EMBANKMENT - PLAN										
104	STAGE 6 TAILINGS EMBANKMENT - MATERIAL SPECIFICATIONS										
REFERENCE DRAWINGS				REVISIONS				REVISIONS			

REV.	DATE	DESCRIPTION	DESIGN	DRAWN	CHK'D	APP'D
0	06JUN'07	ISSUED FOR STAGE 6 PERMITTING	LJG	JY	BB	K/S

VANCOUVER, B.C. CAD FILE: \\A:\1\01\0000\18\VA\Acad\Draw\235\235.dwg 1:25 Scale 15 JUN 2007 8:39pm Time: 15:51

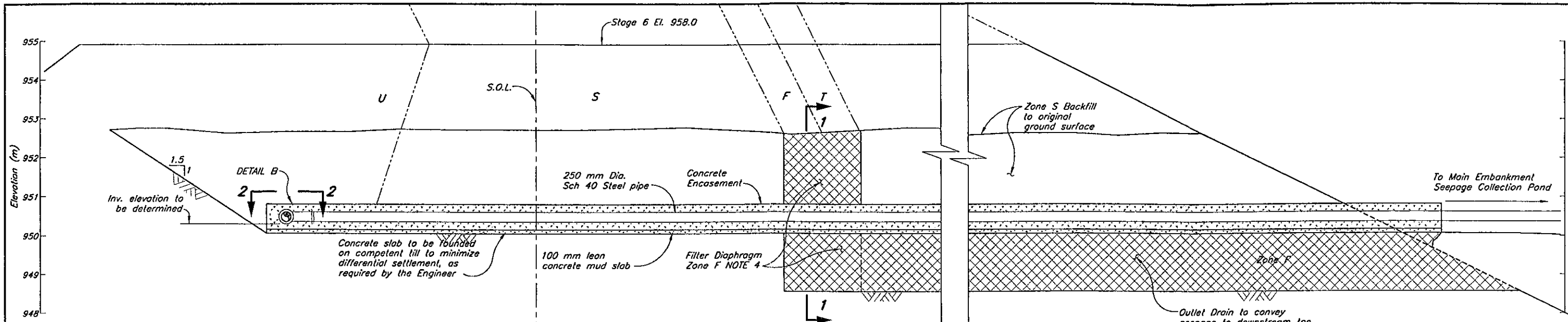

TYPICAL SECTION OF UPSTREAM TOE DRAIN AT ABUTMENTS
Scale A

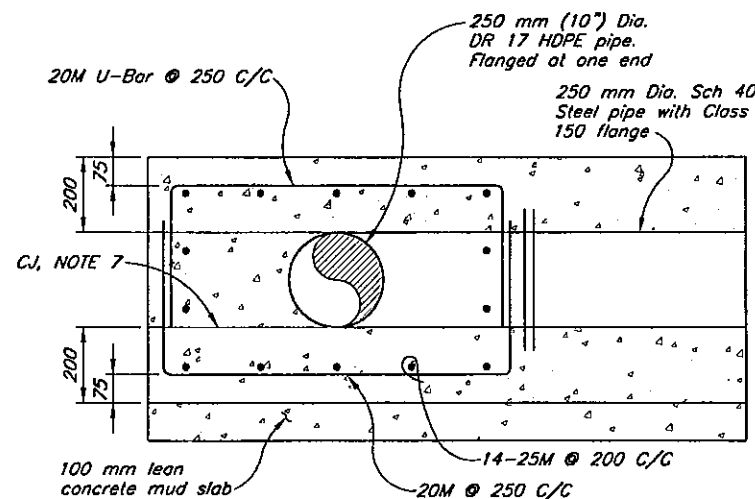

DETAIL B - UPSTREAM TOE DRAIN
CONCRETE ENCASEMENT REINFORCEMENT DETAILS
Scale B

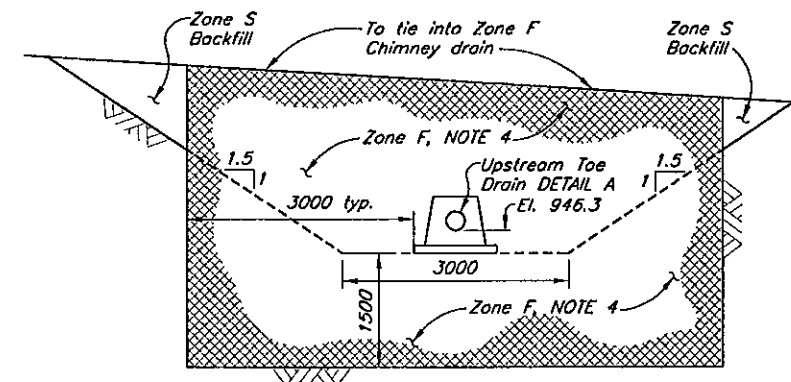

SECTION 1 - FILTER DIAPHRAGM
Scale A

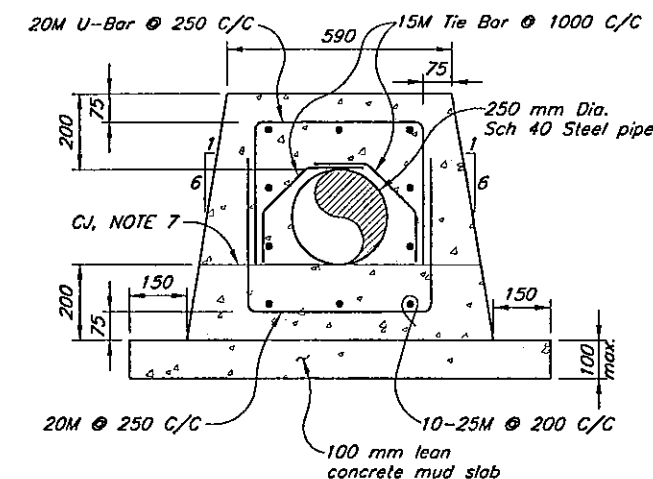

DETAIL A - OUTLET DRAIN
CONCRETE ENCASEMENT REINFORCEMENT DETAILS
Scale B

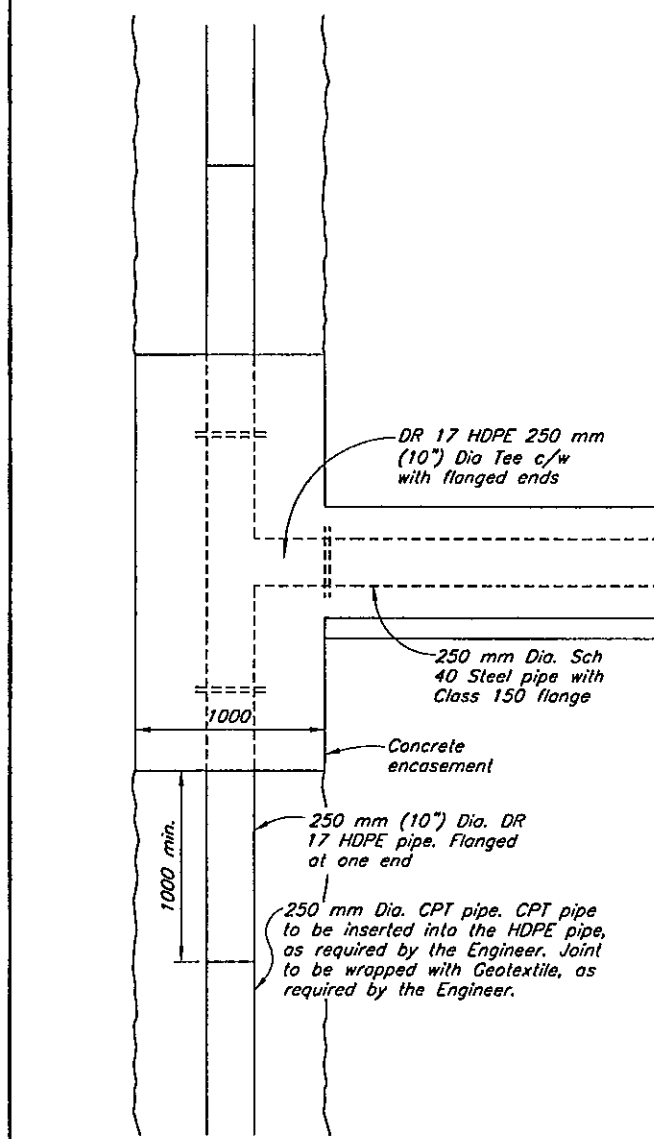

SECTION 2
UPSTREAM TOE DRAIN TO OUTLET DRAIN CONNECTION
Scale C

220	STAGE 6 PERIMETER EMBANKMENT - PLAN							
125	ULTIMATE PERIMETER EMBANKMENT - SECTIONS							
120	ULTIMATE PERIMETER EMBANKMENT - PLAN							
DRC. NO.	DESCRIPTION	REV.	DATE	DESCRIPTION	DESIGN	DRAWN	CHK'D	APP'D
REFERENCE DRAWINGS				REVISIONS				

NOTES

1. Concrete strength: Type C30-20 (30 MPa with 20 mm coarse aggregate).
2. Minimum concrete cover 40mm.
3. Reinforcement steel to CSA G30.18 Grade 400R.
4. Zone F to be placed and spread in maximum 300 mm thick layers and compacted as approved by the Engineer.
5. All dimensions in millimetres and elevations in metres, unless noted otherwise.
6. Upstream Toe Drain Steel pipe and HDPE elbows to be pressure tested for 2 hours at 640 kPa (100 psi.) prior to and after encasing in concrete.
7. After casting first pour and once concrete has achieved initial set, pressure blast horizontal construction joint surface to remove all laitance and expose top surface of coarse aggregate. Do not over-blast or undercut coarse aggregate. Remove all dirt, dust, rubbish and other deleterious material from surface of construction joint prior to casting second pour.

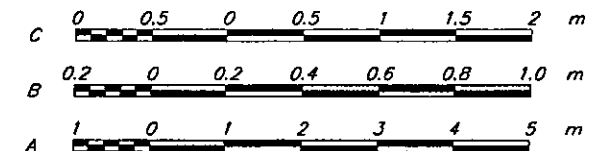

NOT FOR CONSTRUCTION

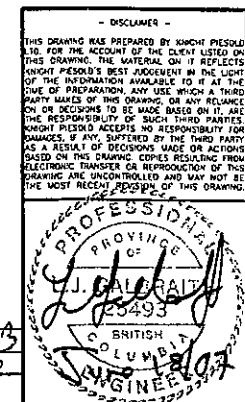

Knights Piesold
CONSULTING

MOUNT POLLEY MINING CORPORATION

MOUNT POLLEY MINE

**TAILINGS STORAGE FACILITY
STAGE 6 - SOUTH EMBANKMENT
UPSTREAM TOE DRAIN
SECTIONS AND DETAILS**

PROJECT/ASSIGNMENT NO. **VA101-1/18** DRAWING NO. **240** REVISION **0**

0	06JUN'07	ISSUED FOR STAGE 6 PERMITTING	LJG	JY	BB	12/83
REV.	DATE	DESCRIPTION	DESIGN	DRAWN	CHK'D	APP'D
REVISIONS			REVISIONS			

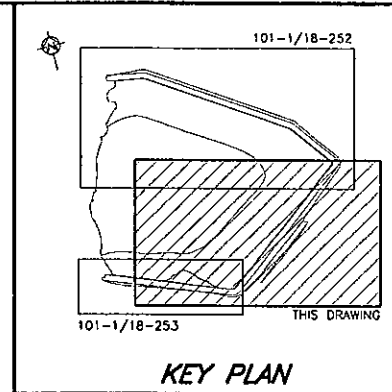
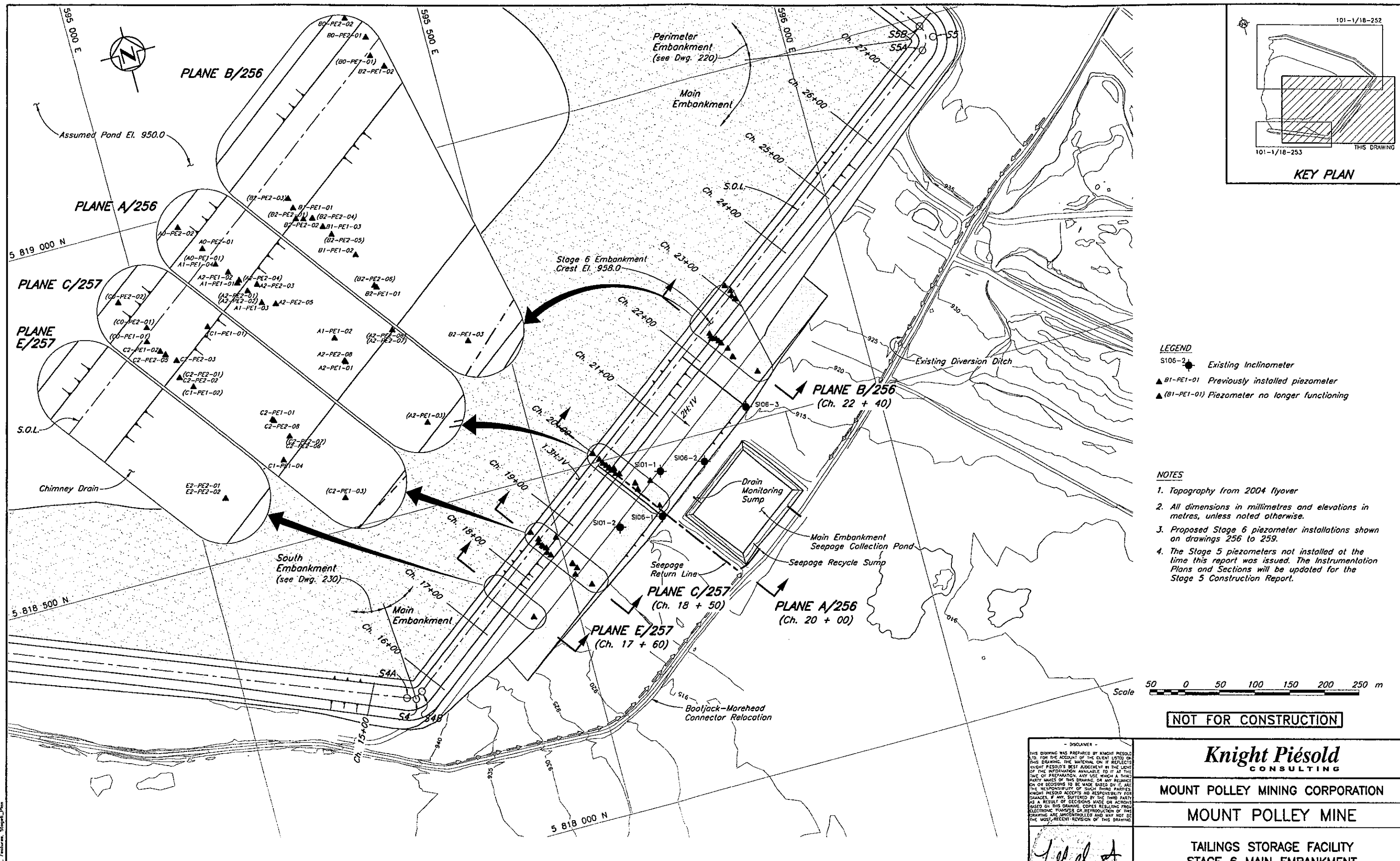

- LEGEND**
- SI06-2 Existing Inclinator
 - ▲ B1-PE1-01 Previously installed piezometer
 - ▲ (B1-PE1-01) Piezometer no longer functioning

- NOTES**
1. Topography from 2004 flyover
 2. All dimensions in millimetres and elevations in metres, unless noted otherwise.
 3. Proposed Stage 6 piezometer installations shown on drawings 256 to 259.
 4. The Stage 5 piezometers not installed at the time this report was issued. The Instrumentation Plans and Sections will be updated for the Stage 5 Construction Report.

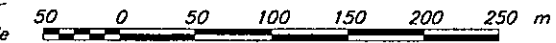

NOT FOR CONSTRUCTION

DISCLAIMER
THIS DRAWING WAS PREPARED BY KNIGHT PIESOLD LTD. FOR THE ACCOUNT OF THE CLIENT LISTED ON THIS DRAWING. THE MATERIAL ON IT REFLECTS KNIGHT PIESOLD'S BEST JUDGMENT IN THE LIGHT OF THE INFORMATION AVAILABLE TO IT AT THE TIME OF PREPARATION. ANY USE WHICH A THIRD PARTY MAKES OF THIS DRAWING, OR ANY RELIANCE ON OR DECISIONS TO BE MADE BASED ON IT, ARE THE RESPONSIBILITY OF SUCH THIRD PARTIES. KNIGHT PIESOLD ACCEPTS NO RESPONSIBILITY FOR DAMAGES, IF ANY, SUFFERED BY THE THIRD PARTIES AS A RESULT OF DECISIONS MADE OR ACTIONS BASED ON THIS DRAWING. COPIES RESULTING FROM ELECTRONIC TRANSFER OR REPRODUCTION OF THIS DRAWING ARE UNCONTROLLED AND MAY NOT BE THE MOST RECENT REVISION OF THIS DRAWING.

Jeffrey A. [Signature]
June 18/07

Knights Piesold CONSULTING

MOUNT POLLEY MINING CORPORATION

MOUNT POLLEY MINE

**TAILINGS STORAGE FACILITY
STAGE 6 MAIN EMBANKMENT
INSTRUMENTATION PLAN**

PROJECT/ASSIGNMENT NO. VA101-1/18 DRAWING NO. 251 REVISION 0

DRG. NO.	DESCRIPTION	REV.	DATE	DESCRIPTION	DESIGN	DRAWN	CHK'D	APP'D
230	STAGE 6 SOUTH EMBANKMENT - PLAN							
220	STAGE 6 PERIMETER EMBANKMENT - PLAN							
215	STAGE 6 MAIN EMBANKMENT - SECTION							
REFERENCE DRAWINGS				REVISIONS				

REV.	DATE	DESCRIPTION	DESIGN	DRAWN	CHK'D	APP'D
0	08JUN'07	ISSUED FOR STAGE 6 PERMITTING	LJG	JY	BS	KJB
REVISIONS				REVISIONS		

XREF FILE: Topo2004_Features_Stage6_Plan

CADD FILE: M:\1\01\00001\BVA\Stage6\Draws\251\251.dwg 1-2500 PLOT: 1-10P3 Jun 12 2007 10:30am E:\1443

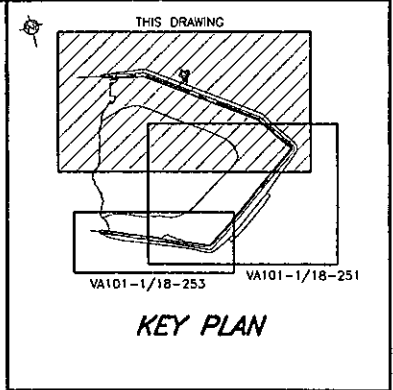
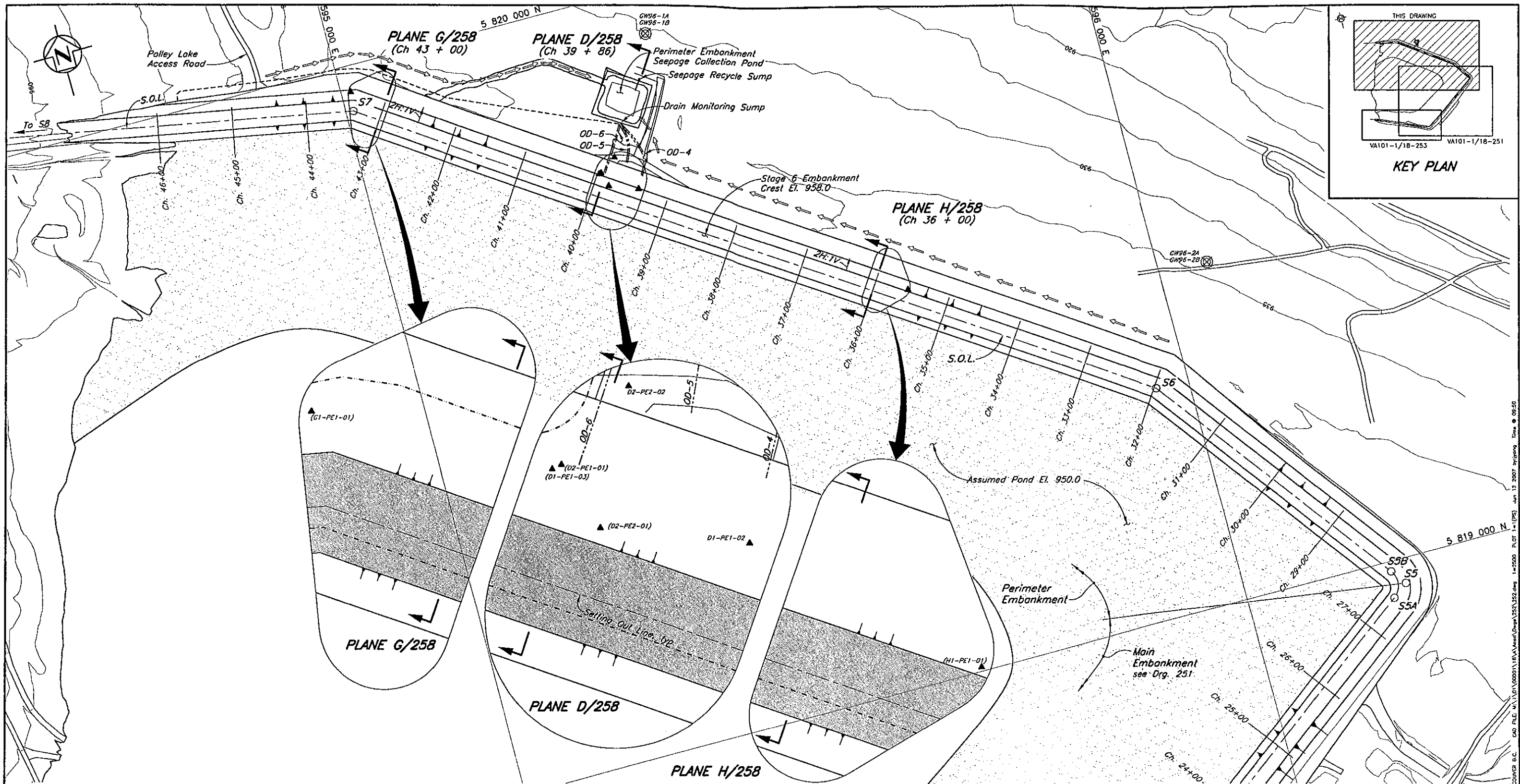

LEGEND

- GW96-9 Groundwater Monitoring Well
- A1-PE1-01 Previously installed Piezometer
- (A1-PE1-01) No longer functioning Piezometer

NOTES

1. Topography from 2004 flyover
2. All dimensions in millimetres and elevations in metres, unless noted otherwise.
3. Proposed Stage 6 piezometer installations shown on drawings 256 to 259.
4. The Stage 5 piezometers not installed at the time this report was issued. The Instrumentation Plans and Sections will be updated for the Stage 5 Construction Report.

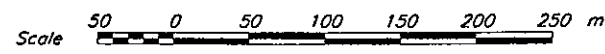

NOT FOR CONSTRUCTION

DRG. NO.	DESCRIPTION
258	STAGE 6 INSTRUMENTATION DRAWINGS - PLANES D, C AND H
257	STAGE 6 INSTRUMENTATION DRAWINGS - PLANES C AND E
253	STAGE 6 SOUTH EMBANKMENT - INSTRUMENT PLAN
251	STAGE 6 MAIN EMBANKMENT - INSTRUMENT PLAN

REV.	DATE	DESCRIPTION	DESIGN	DRAWN	CHK'D	APP'D

REV.	DATE	DESCRIPTION	DESIGN	DRAWN	CHK'D	APP'D
0	08JUN'07	ISSUED FOR STAGE 6 PERMITTING	LJG	JY	BB	K115

PROVIDE OF

Knights Piésold
CONSULTING

MOUNT POLLEY MINING CORPORATION

MOUNT POLLEY MINE

TAILINGS STORAGE FACILITY
STAGE 6
PERIMETER EMBANKMENT - INSTRUMENTATION PLAN

PROJECT/ASSIGNMENT NO.	DRAWING NO.	REVISION
VA101-1/18	252	0

REF. FILE: T:\stage6\dl Stage6_Plan

UNACQUAINTED B.C. CAD FILE: M:\1\01\000011\VA\Stage6\Drawn\252\252.dwg 1=2500 E.S.T. 11/05/07 12:20:07 11/05/07 12:20:07 11/05/07 12:20:07

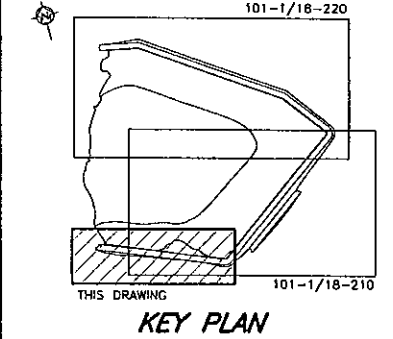
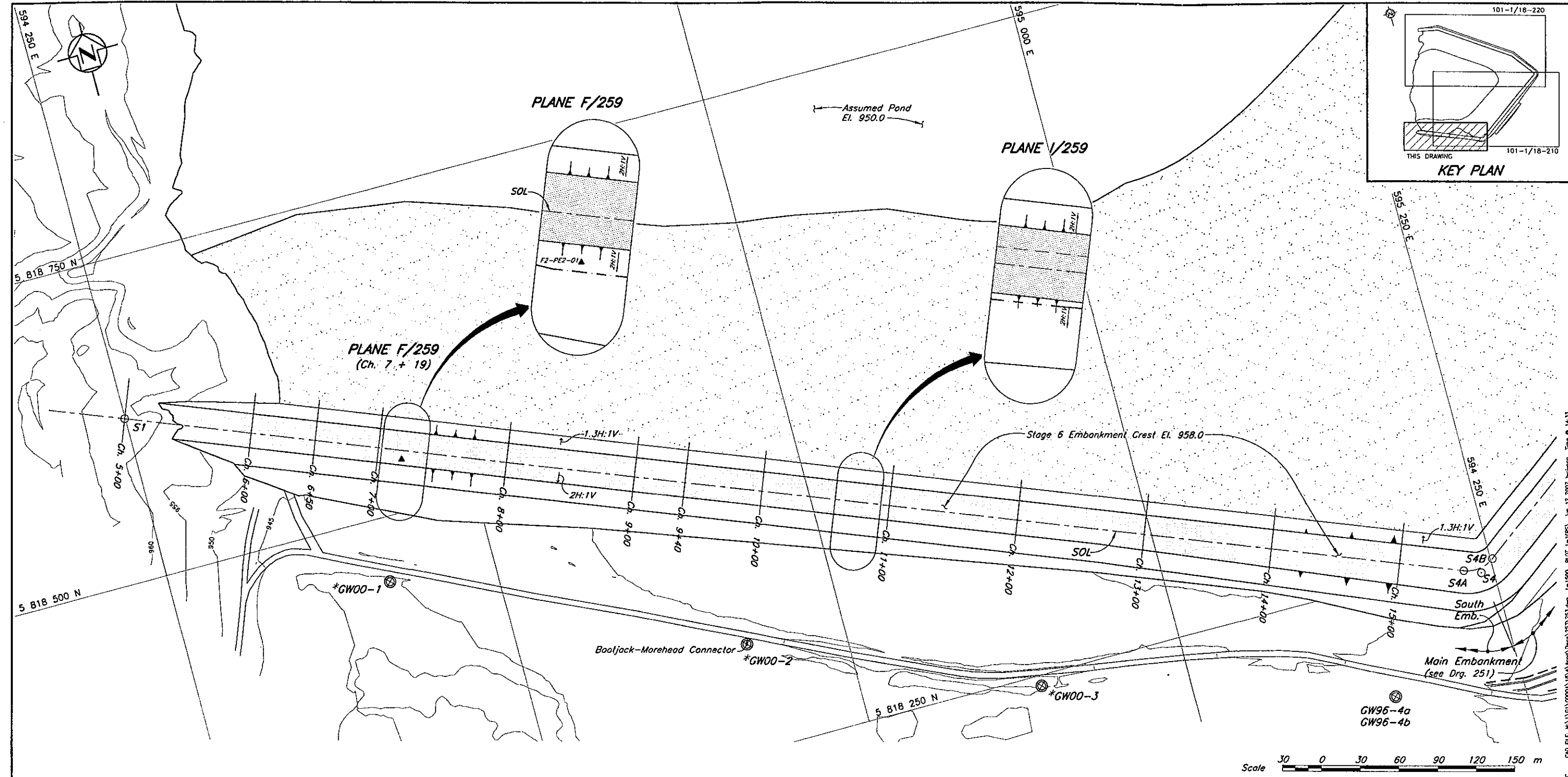

Scale 30 0 30 60 90 120 150 m

NOT FOR CONSTRUCTION

- LEGEND**
- ⊗ GW96-9 Groundwater Monitoring Well
 - ▲ A1-PE1-01 Previously installed Piezometer
 - ▲ (A1-PE1-01) No longer functioning Piezometer

- NOTES**
1. Topography from 2004 flyover
 2. All dimensions in millimetres and elevations in metres, unless noted otherwise.
 3. Proposed Stage 6 piezometer installations shown on drawings 256 to 259.
 4. The Stage 5 piezometers not installed at the time this report was issued. The Instrumentation Plans and Sections will be updated for the Stage 5 Construction Report.

DISCLAIMER
THIS DRAWING WAS PREPARED BY KNIGHT PIESOLD LTD. FOR THE ACCOUNT OF THE CLIENT LISTED ON THIS DRAWING. THE MATERIAL ON IT REFLECTS KNIGHT PIESOLD'S BEST JUDGEMENT IN THE LIGHT OF THE INFORMATION AVAILABLE TO IT AT THE TIME OF PREPARATION. ANY USE WHICH A THIRD PARTY MAKES OF THIS DRAWING OR ANY RELIANCE ON OR DECISIONS TO BE MADE BASED ON IT, ARE THE RESPONSIBILITY OF SUCH THIRD PARTIES. KNIGHT PIESOLD ACCEPTS NO RESPONSIBILITY FOR DAMAGES, IF ANY, SUFFERED BY THE THIRD PARTY AS A RESULT OF DECISIONS MADE OR ACTIONS BASED ON THIS DRAWING. COPIES RESULTING FROM ELECTRONIC TRANSFER OR REPRODUCTION OF THIS DRAWING ARE UNCONTROLLED AND MAY NOT BE THE MOST RECENT VERSION OF THIS DRAWING.

PROFESSIONAL ENGINEER
J. J. J. J.
5493
BRITISH COLUMBIA

Knicht Piésold CONSULTING

MOUNT POLLEY MINING CORPORATION

MOUNT POLLEY MINE

TAILINGS STORAGE FACILITY
STAGE 6
SOUTH EMBANKMENT - INSTRUMENTATION PLAN

PROJECT/ASSIGNMENT NO. VA101-1/18 DRAWING NO. 253 REVISION 0

DRG. NO.	DESCRIPTION
259	STAGE 6 INSTRUMENTATION DRAWINGS - PLANES F AND I
252	STAGE 6 PERIMETER EMBANKMENT - INSTRUMENT PLAN
251	STAGE 6 MAIN EMBANKMENT - INSTRUMENT PLAN

REV.	DATE	DESCRIPTION	DESIGN	DRAWN	CHK'D	APP'D

REV.	DATE	DESCRIPTION	DESIGN	DRAWN	CHK'D	APP'D
0	08JUN'07	ISSUED FOR STAGE 6 PERMITTING	LJG	JY	BB	RIS

XREF FILE: Topo2004_CA_Stage6_Plan

VANCOUVER B.C. CAD FILE: H:\1\01\0000\1\BVA\head\Stage6\STG653.dwg 1:1500 PLOT: 1:-(P) Sun 12 2007 by: jmg Time: 14:33

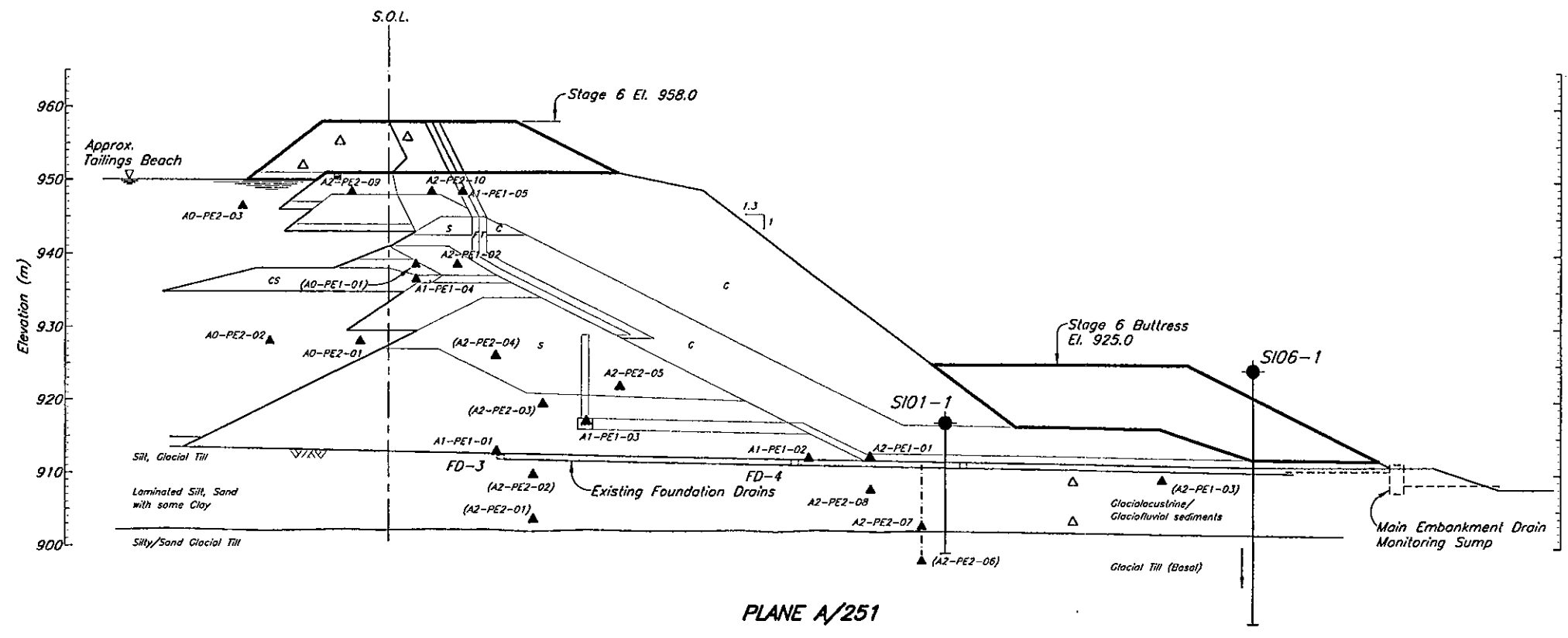

PLANE A/251

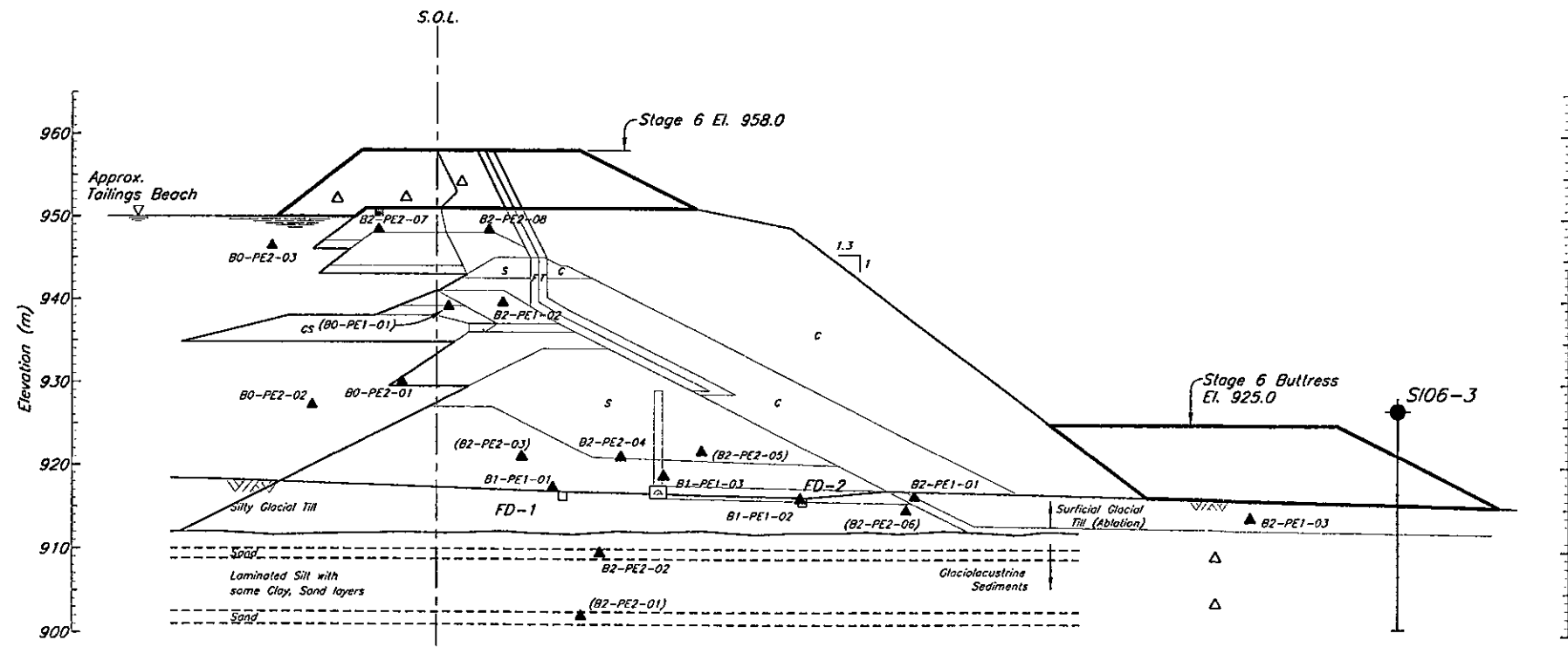

PLANE B/251

- LEGEND**
- Plane I.D. (A, B etc.)
 - Area (0-Tailings, 1-Drain, 2-Embankment)
 - AO-PE1-01—Number I.D.
 - Pressure Rating (1-Low, 2-High)
 - Type of Instrumentation (PE—Piezometer electric, SM—Survey Monument)
 - ▲ A2-PE2-03 Previously installed Piezometer
 - △ Proposed Stage 6 Piezometers

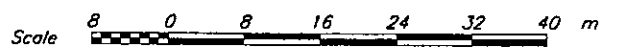

NOT FOR CONSTRUCTION

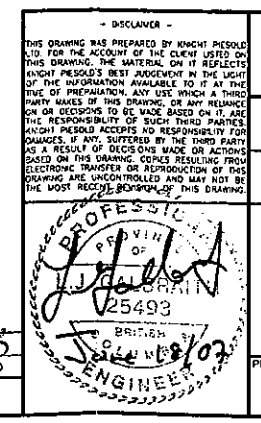

Knight Piésold
CONSULTING

MOUNT POLLEY MINING CORPORATION
MOUNT POLLEY MINE

TAILINGS STORAGE FACILITY
STAGE 6 – INSTRUMENTATION
MAIN EMBANKMENT
PLANES A AND B

PROJECT/ASSIGNMENT NO. VA101-1/18 DRAWING NO. 256 REVISION 0

257	STAGE 6 INSTRUMENTATION DRAWINGS – PLANES C AND E
210	TSF – MAIN EMBANKMENT – PLAN
DRG. NO.	DESCRIPTION
REFERENCE DRAWINGS	

REV.	DATE	DESCRIPTION	DESIGN	DRAWN	CHK'D	APP'D
REVISIONS						

REV.	DATE	DESCRIPTION	DESIGN	DRAWN	CHK'D	APP'D
0	08JUN'07	ISSUED FOR STAGE 6 PERMITTING	LJG	JY	BS	RIS
REVISIONS						

CAD FILE: H:\1\01\00001\18\VA_Knight\Draws\256\256.dwg 1:400 PLOT 1:1 (PE) Jun 15 2007 by:jmgg Time: 15:30
 VANCOUVER, B.C.

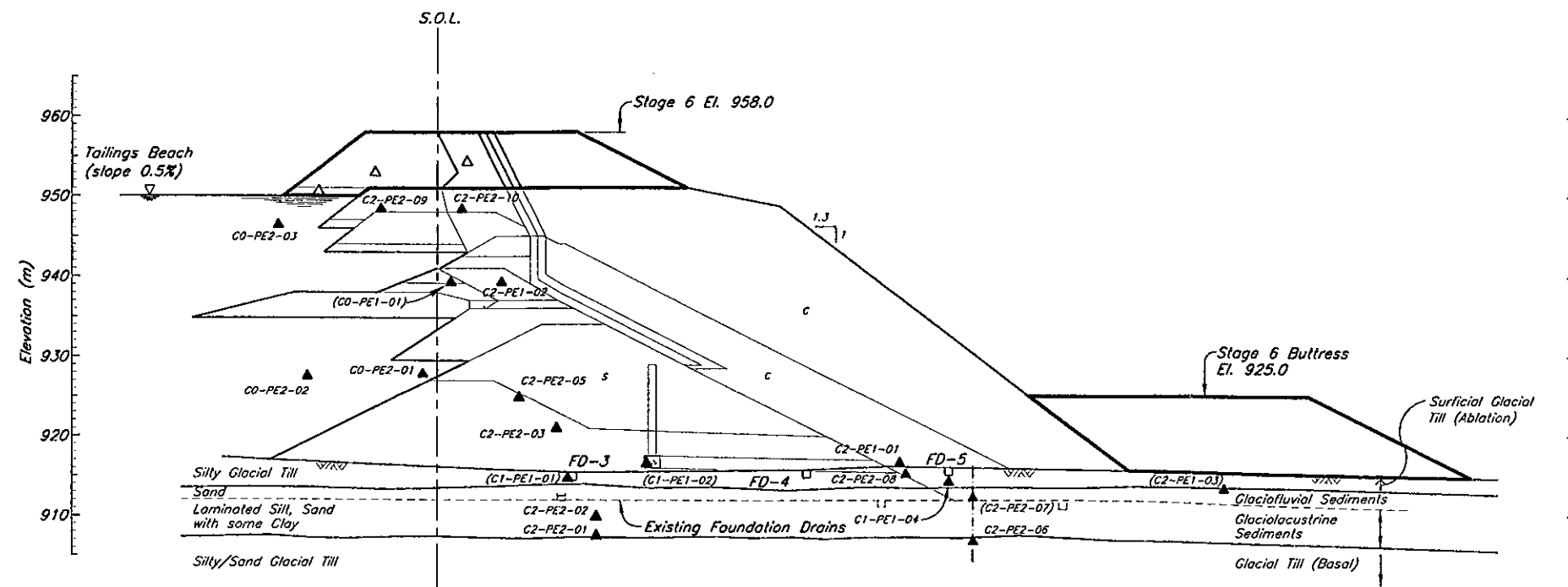

PLANE C/251

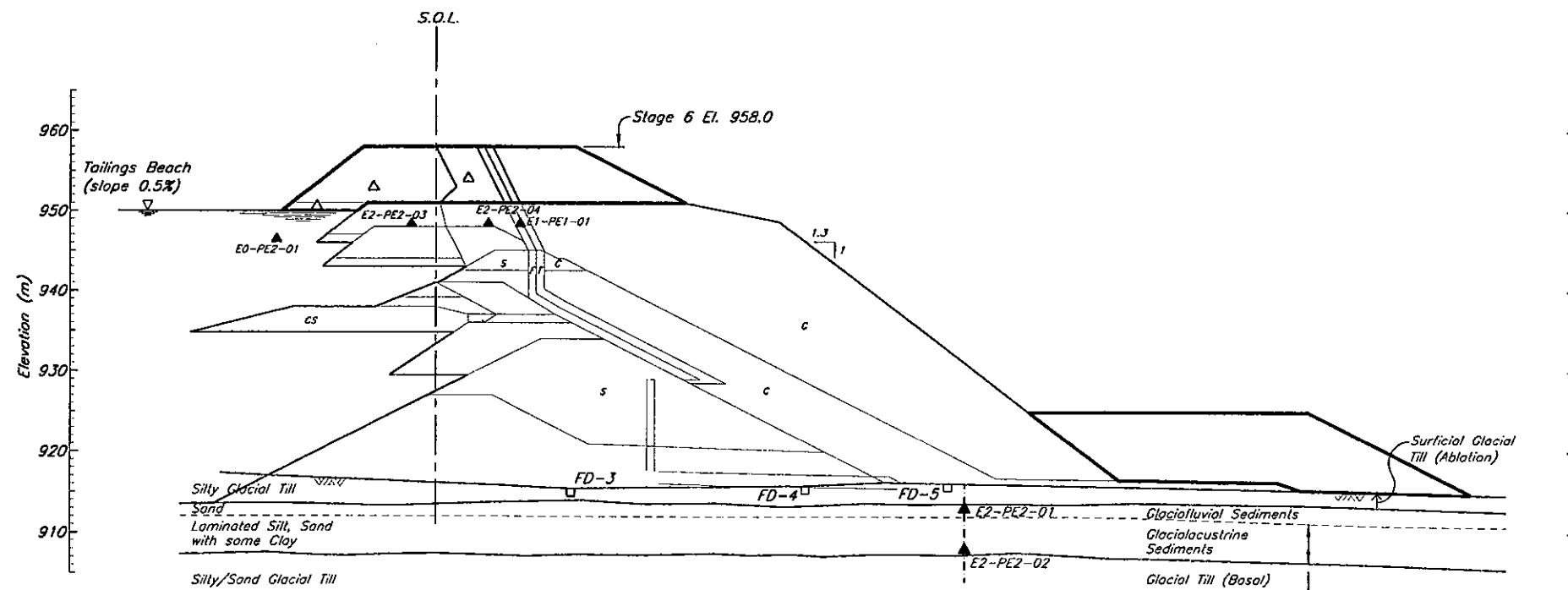

PLANE E/251

- LEGEND**
- Plane I.D. (A, B etc.)
 - Area (0-Tailings, 1-Drain, 2-Embankment)
 - AO-PE1-01 — Number I.D.
 - Pressure Rating (1-Low, 2-High)
 - Type of Instrumentation (PE-Piezometer electric, SM-Survey Monument)
 - A2-PE2-03 ▲ Previously installed Piezometer
 - ▲ Proposed Stage 6 Piezometers

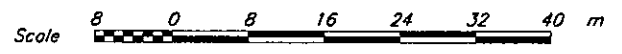

NOT FOR CONSTRUCTION

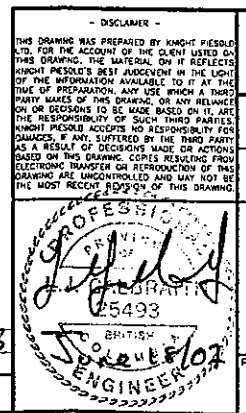

Knights Piésold CONSULTING

MOUNT POLLEY MINING CORPORATION

MOUNT POLLEY MINE

TAILINGS STORAGE FACILITY
STAGE 6 - INSTRUMENTATION
MAIN EMBANKMENT
PLANES C AND E

PROJECT/ASSIGNMENT NO. VA101-1/18 DRAWING NO. 257 REVISION 0

DRG. NO.	DESCRIPTION	REV.	DATE	DESCRIPTION	DESIGN	DRAWN	CHK'D	APP'D
256	STAGE 6 INSTRUMENTATION DRAWINGS - PLANES A AND B							
210	TSF - PERIMETER EMBANKMENT - PLAN							

REV.	DATE	DESCRIPTION	DESIGN	DRAWN	CHK'D	APP'D

REV.	DATE	DESCRIPTION	DESIGN	DRAWN	CHK'D	APP'D
0	08JUN'07	ISSUED FOR STAGE 6 PERMITTING	LJG	JY	BB	ZJB

W:\COVER B.C. CAD FILE: H:\1\01\050001\01\VA\Acad\Drawings\257\257.dwg 1=00 PLOT 1=1(PS) Jun 15 2007 8:59pm Times 1549

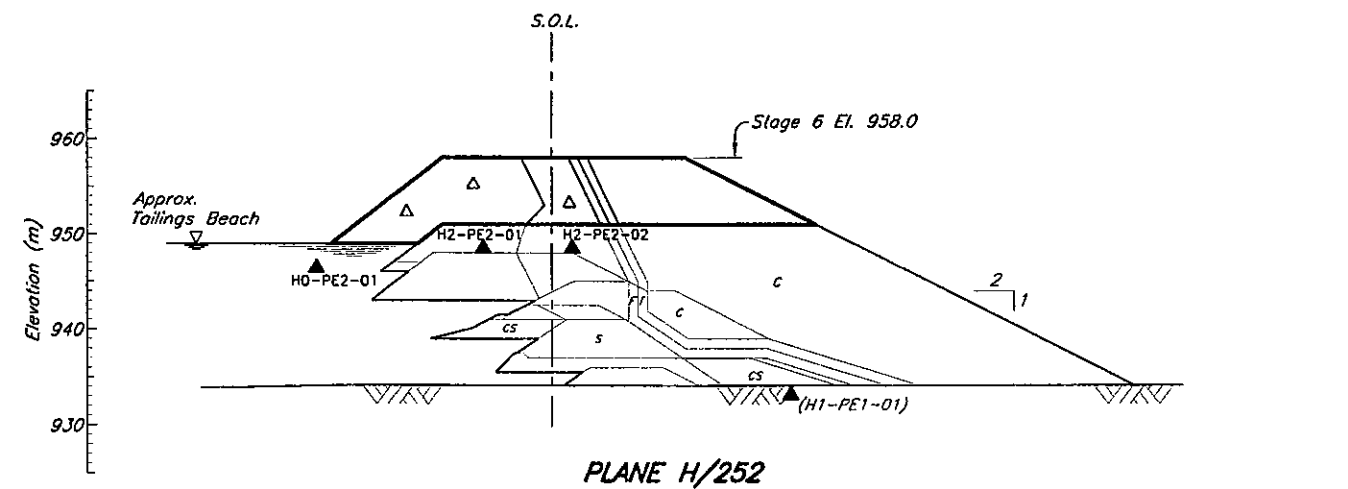
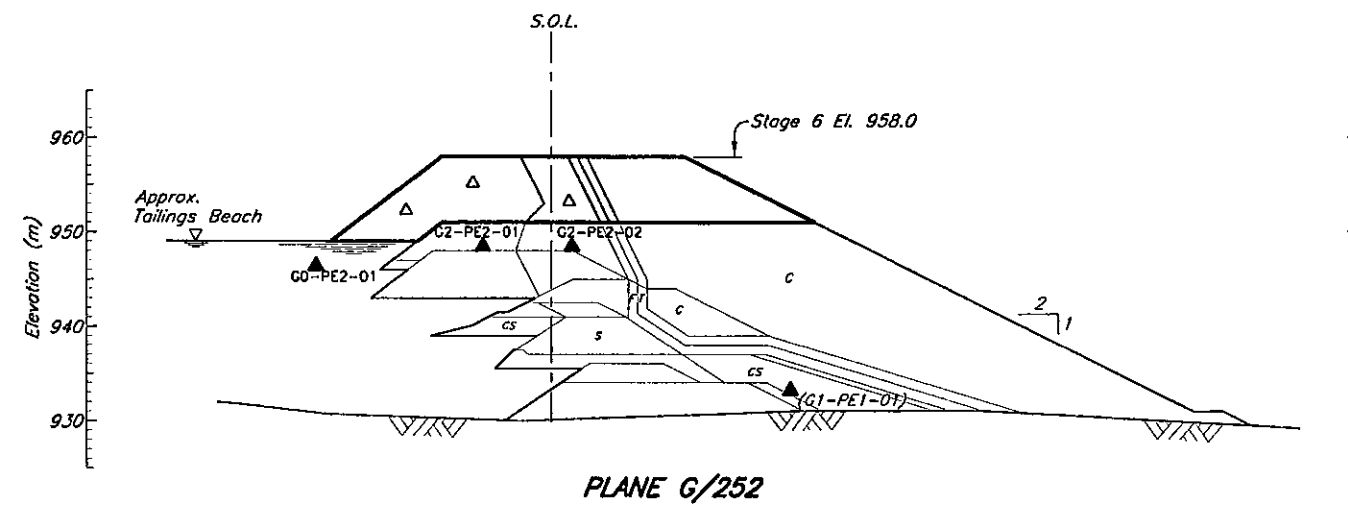
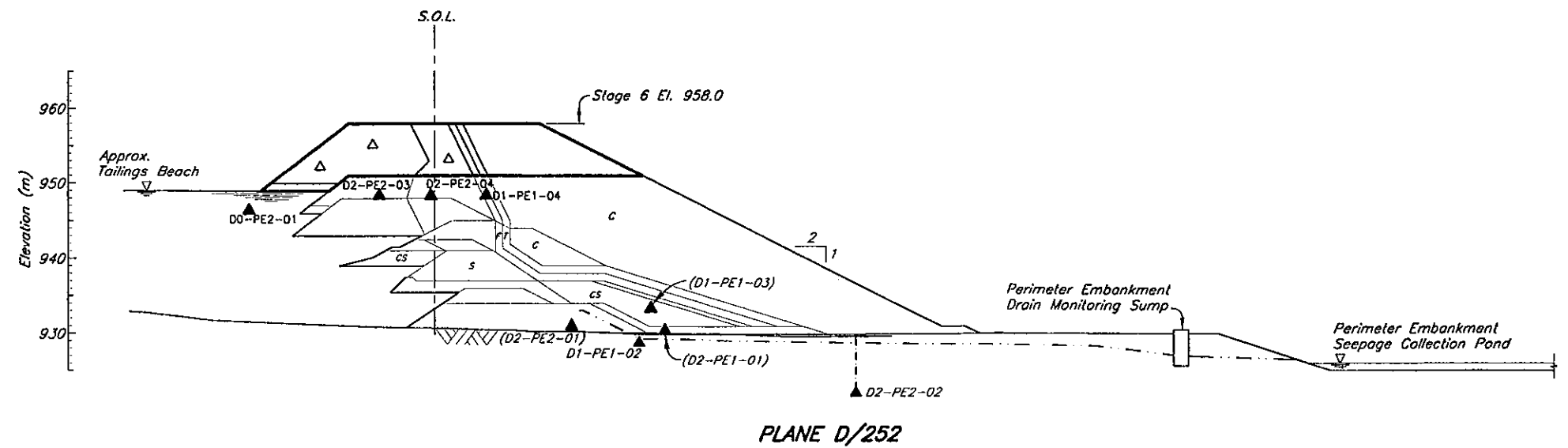

- LEGEND**
- Plane I.D. (A, B etc.)
 - Area (0-Tailings, 1-Drain, 2-Embankment)
 - A0-PE1-01— Number I.D.
 - Pressure Rating (1-Low, 2-High)
 - Type of Instrumentation (PE-Piezometer electric, SM-Survey Monument)
 - A2-PE2-03 ▲ Previously installed Piezometer
 - △ Proposed Stage 6 Piezometers

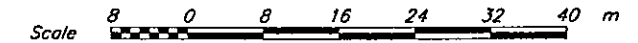

NOT FOR CONSTRUCTION

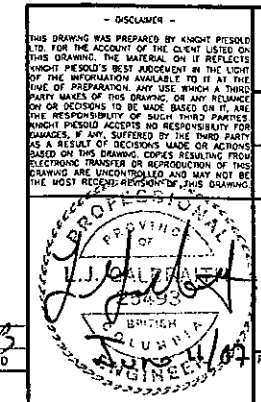

Knights Piésold CONSULTING

MOUNT POLLEY MINING CORPORATION

MOUNT POLLEY MINE

**TAILINGS STORAGE FACILITY
STAGE 6 - INSTRUMENTATION
PERIMETER EMBANKMENT
PLANES D, G AND H**

PROJECT/ASSIGNMENT NO. **VA101-1/18** DRAWING NO. **258** REVISION **0**

256	STAGE 6 INSTRUMENTATION DRAWINGS - PLANES A AND B
220	STAGE 6 PERIMETER EMBANKMENT - PLAN
ORC. NO.	DESCRIPTION
	REVISIONS

REV.	DATE	DESCRIPTION	DESIGN	DRAWN	CHK'D	APP'D
0	08JUN'07	ISSUED FOR STAGE 6 PERMITTING	LJC	JY	BS	KLB

REV.	DATE	DESCRIPTION	DESIGN	DRAWN	CHK'D	APP'D
0	08JUN'07	ISSUED FOR STAGE 6 PERMITTING	LJC	JY	BS	KLB

W:\PROJECTS\2007\VA101-1\18\VA101-1-18-258.dwg 1=400 PLOT 1=1 (PS) Jun 08 2007 by:jms Time: 13:08
 VANCOUVER B.C. CAD FILE: M:\V\01\00001\18\VA101-1\18-258.dwg 1=400 PLOT 1=1 (PS) Jun 08 2007 by:jms Time: 13:08

APPENDIX A

OVERVIEW OF 2006 DAM SAFETY REVIEW

(Pages A1 to A4)

APPENDIX A

OVERVIEW OF 2006 DAM SAFETY REVIEW

General

A Dam Safety Review (DSR) for the Tailings Storage Facility at Mount Polley Mine was completed by AMEC in October 2006. The results of the DSR were issued in a report to Imperial Metals Corporation in December 2006. The DSR indicated that "the three embankments that impound the Mount Polley Tailings are well designed and well constructed entities from a dam safety perspective. Each of the three dams has demonstrated similar good performance behaviour with little indication of potential concerns in the future provided the design, continuance of past construction practices, and inspection procedures remain in place".

However, there were a few operational issues raised in the DSR, as discussed below:

- 1. Operating criteria for pond and beach management are presently at odds with the optimal dam seepage performance and stated closure objectives, with the latter issue being of greatest concern.*

A beach width of at least 20 m is to be maintained along the abutments of the embankments (where the embankment contacts natural ground) and at least 10 m width elsewhere to keep the pond away from the embankments. Knight Piésold has recommended that MPMC develop a plan and schedule to enable the minimum target beach widths to be re-established within a 2 week period should they be infringed upon. MPMC shall increase the frequency of measurements to at least once per week for embankment instrumentation systems (piezometers and foundation drains - flow rate and turbidity) during any periods that ponded water encroaches within the minimum target beach widths.

The use of tailings sand is currently being used as upstream Zone U construction material. Zone U forms the upstream shell zone immediately adjacent to Zone S (low permeability core zone) and is required to provide upstream support of the Zone S material during modified centerline construction. The sand cell construction method involves discharging tailings into constructed cells along the upstream side of the embankment. Prolonged discharge of tailings from the Perimeter Embankment has resulted in the tailings pond migrating over to the Main Embankment, which has resulted in increased flows reporting to the Main Embankment upstream toe drain. MPMC has recently purchased additional HDPE pipe to facilitate the deposition of tailings from around the entire facility without having to relocate the tailings pipeline. This will allow MPMC to quickly develop tailings beaches in response to the pond encroaching on the embankments.

The current mine plan has the mine operating at 20,000 tpd for the next 8 years. It is recognized that improvements in tailings deposition will be beneficial for optimizing beach development round the facility but this is only a minor consideration for closure planning. The current tailings deposition practices are not particularly relevant for the closure plan unless one considers sudden pre-mature mine closure during the next few months which is extremely unlikely (impossible?) given current metal prices and excellent operating performance of the Mount Polley Mine. This

concern, expressed in the DSR with respect to satisfying closure objectives are not particularly relevant during the current stage of mine operations. The closure objectives for the TSF are currently under review by MPMC. The tailings pond will continue to be managed in accordance with the TSF closure objectives in the later years of the mine life.

- 2. As the facility has no operating spillway, the selection of the 24-hour PMP event may not be appropriately conservative. The amount of wave induced freeboard being allowed for is likely excessive by a factor of two.*

The previous design basis required the TSF to have sufficient live storage capacity for containment of runoff from the 24-hour PMP volume of 679,000 m³ at all times, which would result in an incremental rise in the tailings pond level of approximately 0.4 m. The 24-hour PMP allowance was in addition to regular inflows from other precipitation runoff, including the spring freshet. The TSF design also incorporated an additional allowance of 1 meter of freeboard for wave run-up, for total freeboard requirement of 1.4 m.

The design basis has been updated to include storm water freeboard for the 72-hour PMP event. The volume of water associated with the 72-hour PMP event is approximately 1,070,000 m³, which would result in an increase in the TSF pond elevation of approximately 0.6 m. The freeboard requirement for wave run-up has been reduced to 0.7 m, for total updated freeboard requirement of 1.3 m, which is consistent with the previous freeboard requirement. However, MPMC has elected to maintain the previous freeboard requirement of at least 1.4 m for the remaining mine life. The freeboard requirement post closure will be reviewed as part of the closure and reclamation plans as they are updated.

- 3. The lack of potential of the nature of pre-shearing in the glaciolacustrine foundation leads to uncertainty in terms of present and post closure stability. There is an uncertainty in the need, or lack thereof, of the closure berm.*

Knight Piésold has been studying the lacustrine unit at the Main Embankment and investigating the potential for a weak layer within this unit since the initial design of the TSF embankments. The upper portion of this unit was investigated thoroughly by Knight Piésold during the excavation of the Main Embankment Seepage Collection Pond during the initial construction program in 2006, and no evidence of a pre-shear or a weak layer within this unit was discovered. The Lacustrine unit was also investigated in 1996 (CPT drilling) and in 2001 and 2006 when the inclinometers were installed. The results of the investigations indicate that the lacustrine unit is typically comprised of very stiff silt and clay. However, this does not prove that a pre-sheared or weak layer could not exist within the unit and it is therefore prudent to incorporate suitable contingency features in the design of the embankment. This has resulted in the installation of five inclinometers (of which four are still functioning) at the Main Embankment and the inclusion of a downstream closure buttress. The inclinometers are read on a regular basis during construction programs with an inclinometer probe and no deviations have been observed to date. The results of the readings for the inclinometers are shown in Appendix B.

The Stage 6 design of the TSF includes provisions to ensure stability in the event that a weak layer exists in the lacustrine material. A buttress at the Main Embankment has been included in the design to ensure that the integrity of the Main Embankment is not compromised by a

potentially weak layer in the lacustrine unit, even though there is no direct evidence that indicates that such a feature is present.

A study comparing the drained residual strength to the clay content, liquid limit, and effective normal stress was completed by Stark and Eid (1995). The results of the study indicate that the residual strength of a material with a clay content ranging from 25 to 50%, with a liquid of 40%, and an effective normal stress of 700 kPa is in the order of 24 degrees. Samples of the lacustrine material have recently been collected for direct shear testing, as recommended in the DSR, however the testing had not been completed at the time this report was issued. The results of the direct shear tests will be reviewed once received and the design of the Stage 6 buttress will be adjusted if required.

- 4. The hazard classification of the TSF embankments is "HIGH" and is based on the economic and social loss category. The classification based on the Loss of Life and Environmental Loss Categories is LOW. The DSR recommends that the hazard classification be reviewed assuming that the owner's costs are not included.*

The classification of the TSF has been assessed using the Canadian Dam Association and the British Columbia Dam Safety Regulation guidelines. These guidelines look at the consequences of failure and consider life safety, economic and social losses, and environmental and cultural losses. The life safety category considers the potential for multiple loss of life after ascertaining the degree of development within the inundation area. The economic and social loss category considers damage to infrastructure, public and commercial facilities that are in and beyond the inundation area. This includes damage to railways, highways, powerlines, residences etc. The environmental and cultural loss considers damage to fish habitat at the regional, provincial, and national level, wildlife habitat, including water quality, and unique landscapes or sites of cultural significance.

Previous assessments of the TSF have resulted in a "HIGH" hazard classification (or consequence category) based on the economic and social loss category. The classification for the life safety and environmental and cultural loss categories is "LOW", as there is low potential for loss of life, the inundation area is typically undeveloped, and there is unlikely to be loss or significant deterioration of provincially or nationally important fish habitat. However, the estimated costs associated with repairing any damage to the TSF, loss of service to the mine, and the potential economic impact on Imperial Metals, could exceed \$1,000,000, which placed the TSF into the "HIGH" economic and social losses category under the British Columbia Dam Safety Regulation guidelines.

The hazard classification of the TSF was discussed with MPMC and it was agreed that the owner's costs should not be included in the classification of the TSF embankments. The hazard classification for the TSF embankments has therefore been reduced to "LOW", based on the Canadian Dam Association and the British Columbia Dam Safety Regulation guidelines.

The maximum design earthquake (MDE) for the TSF with a LOW hazard classification is the 1 in 1000 year event. This corresponds to a peak ground acceleration of 0.096, based on the 2005 National Building Code Seismic Hazard Classification.

5. *There were "about the right" number of piezometers installed in the embankment dams, however there is nothing in the way of much redundancy and any lost instrument locations need to be re-established with a new installation.*

A total of 57 vibrating wire piezometers have been installed at the TSF as of the end of the Stage 4 construction program. The piezometers are grouped into tailings, foundation, embankment fill and drain piezometers. A total of 22 piezometers were accidentally destroyed during the Stage 4 construction program, and six additional piezometers have previously stopped functioning. MPMC and Knight Piésold attempted to locate and splice the damaged piezometers and successfully repaired five of them. The number of functioning piezometers at the end of the Stage 4 construction program was 34. Additional piezometers will be installed in the tailings and embankment fill materials and tailings during the Stage 5 construction program, which is currently in progress.

No unexpected or anomalous pore pressures have been observed while monitoring the vibrating wire piezometers during the TSF construction programs. The timeline plots for the piezometers on planes A through I are provided in Appendix A. The timeline plots indicate that the pore pressures increased slightly in piezometers A2-PE2-03, B2-PE2-03, and B2-PE1-02, which are fill piezometers installed in the Zone S glacial till. These pore pressure increases were expected as these piezometers have shown similar trends in previous construction programs where the pore pressures have increased during fill placement activities and subsequently decreased following the construction programs as the pore pressures dissipate. The pore pressures have also increased in the piezometers installed in the tailings, which is a direct result of the increase in elevation of the tailings pond. There has been no increase in the pore pressures in the foundation piezometers.

Although a number of piezometers are no longer functioning at the TSF, replacing all of them is not practical nor considered necessary at this time as there are functioning piezometers in the vicinity of most that were damaged. However, five of the damaged piezometers were foundation piezometers at the Main Embankment, where there are slight artesian conditions (less than 3.0 m). Additional piezometers will be installed in the Main Embankment foundation materials during Stage 6 to offset those that are no longer functioning. The foundation piezometers at the Main Embankment will have a trigger level of 15 m above ground, which corresponds to the elevated pore pressure that reduces the factor of safety to 1.1.

APPENDIX B

INSTRUMENTATION MONITORING

(Pages B1 to B12)

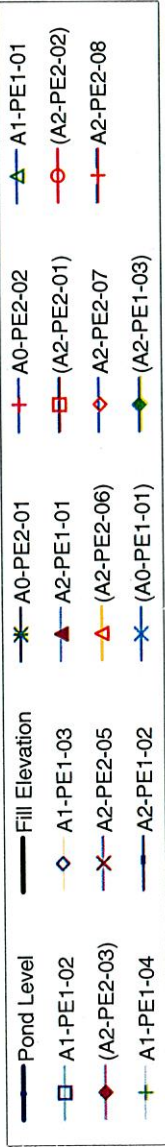
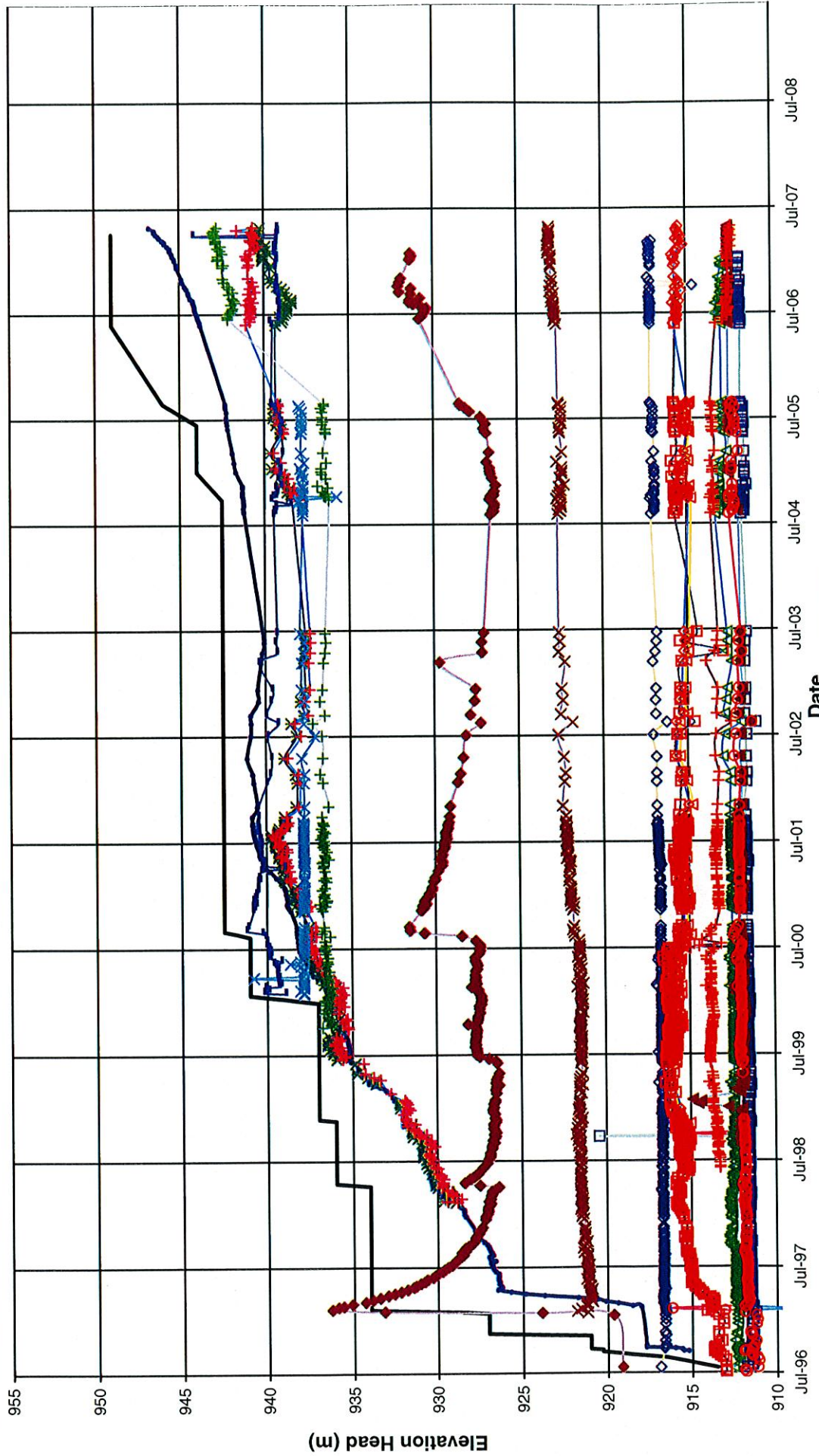

Note:
 1. Piezometers in parenthesis no longer functioning.
 2. Figure does not show the Stage 5 and Stage 6 piezometers as they have yet to be installed.

MOUNT POLLEY MINING CORPORATION
 MOUNT POLLEY MINE
 TAILINGS STORAGE FACILITY
 PLANE A PIEZOMETERS
 GRAPH OF ELEVATION HEAD vs. TIME

Knight Piesold
 CONSULTING

PROJECT NO.	REF. NO.	REV.
VA101-1/18	1	0

FIGURE B-1

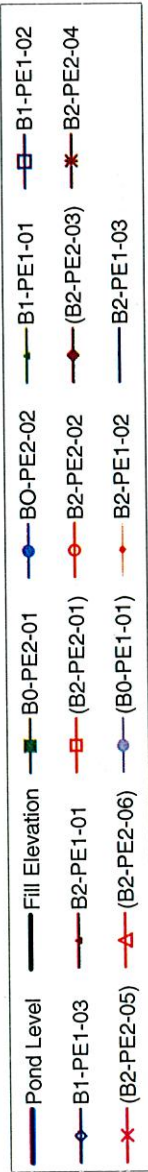
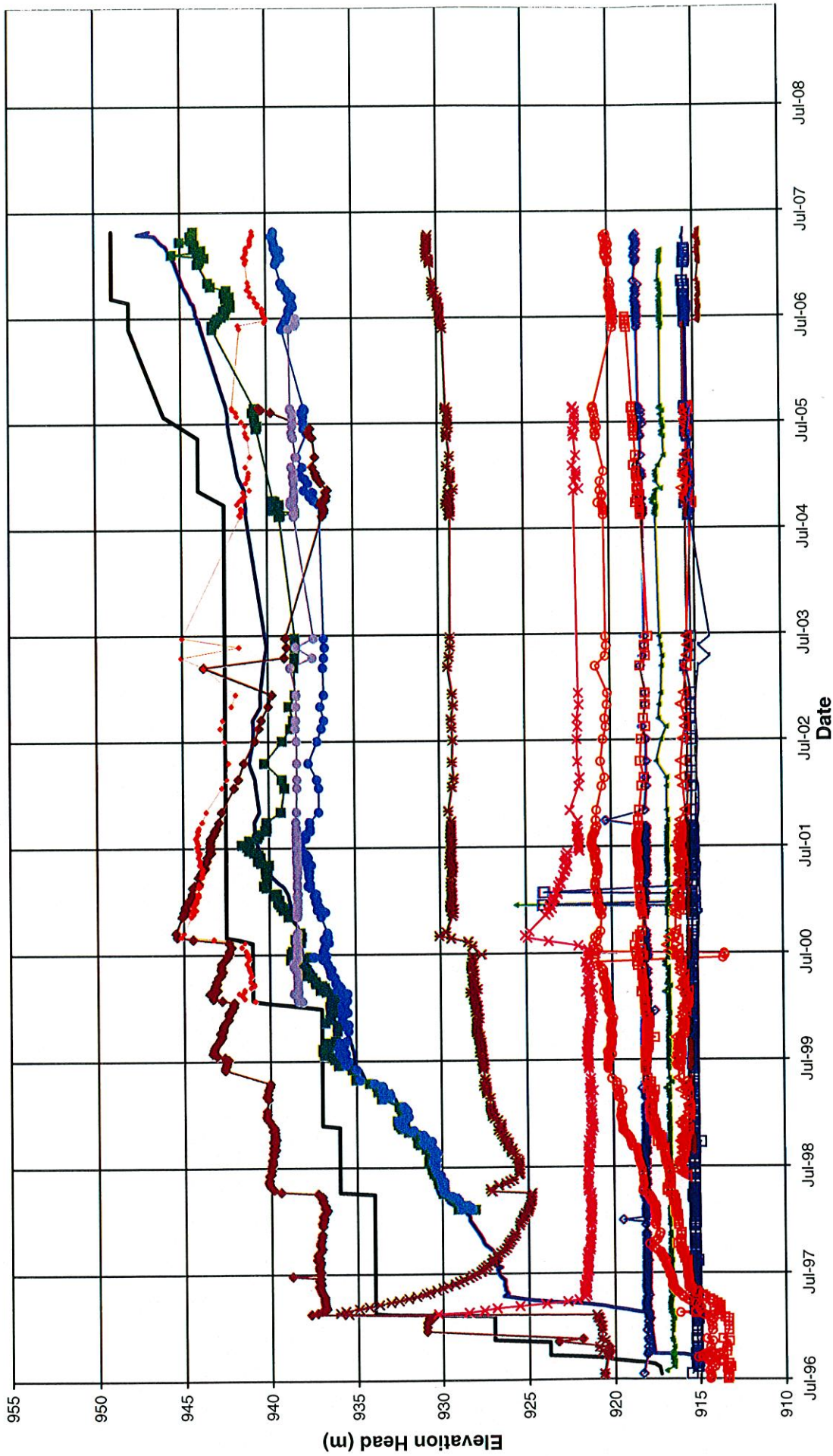

Note:
 1. Piezometers in parenthesis no longer functioning.
 2. Figure does not show the Stage 5 and Stage 6 piezometers as they have yet to be installed.

MOUNT POLLEY MINING CORPORATION
 MOUNT POLLEY MINE
 TAILINGS STORAGE FACILITY
 PLANE B PIEZOMETERS
 GRAPH OF ELEVATION HEAD vs. TIME

Knight Piésold
 CONSULTING

PROJECT NO.	REF. NO.	REV.
VA 101-1/18	1	0

FIGURE B-2

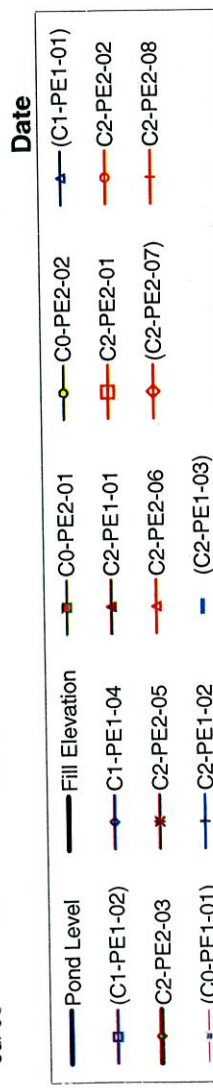
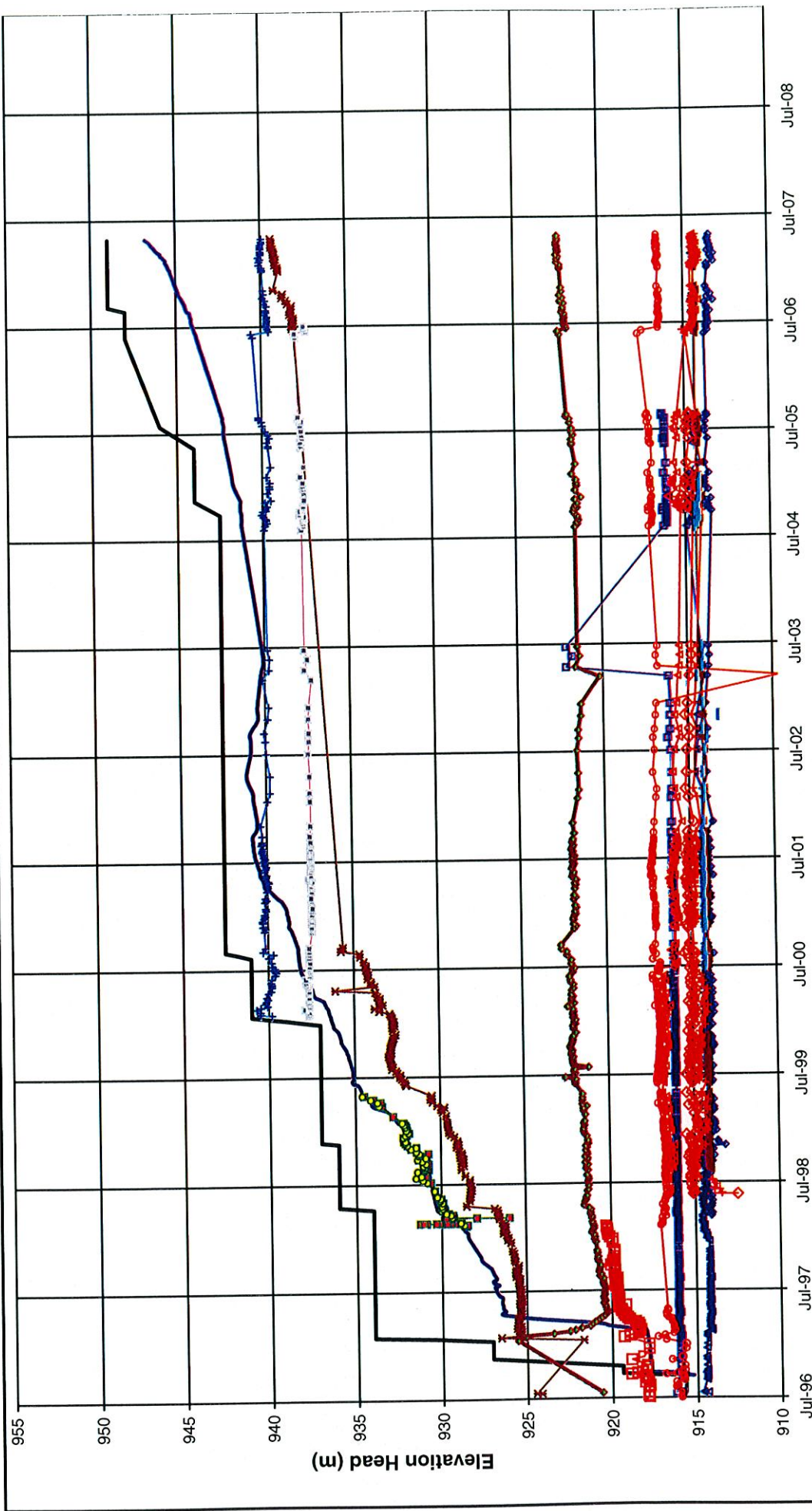

MOUNT POLLEY MINING CORPORATION
 MOUNT POLLEY MINE
 TAILINGS STORAGE FACILITY
 PLANE C PIEZOMETERS
 GRAPH OF ELEVATION HEAD vs. TIME

Knight Piésold
 CONSULTING

PROJECT NO.	REF. NO.	REV
VA 101-1718	1	0

FIGURE B-3

Note:
 1. Piezometers in parenthesis no longer functioning.
 2. Figure does not show the Stage 5 and Stage 6 piezometers as they have yet to be installed.

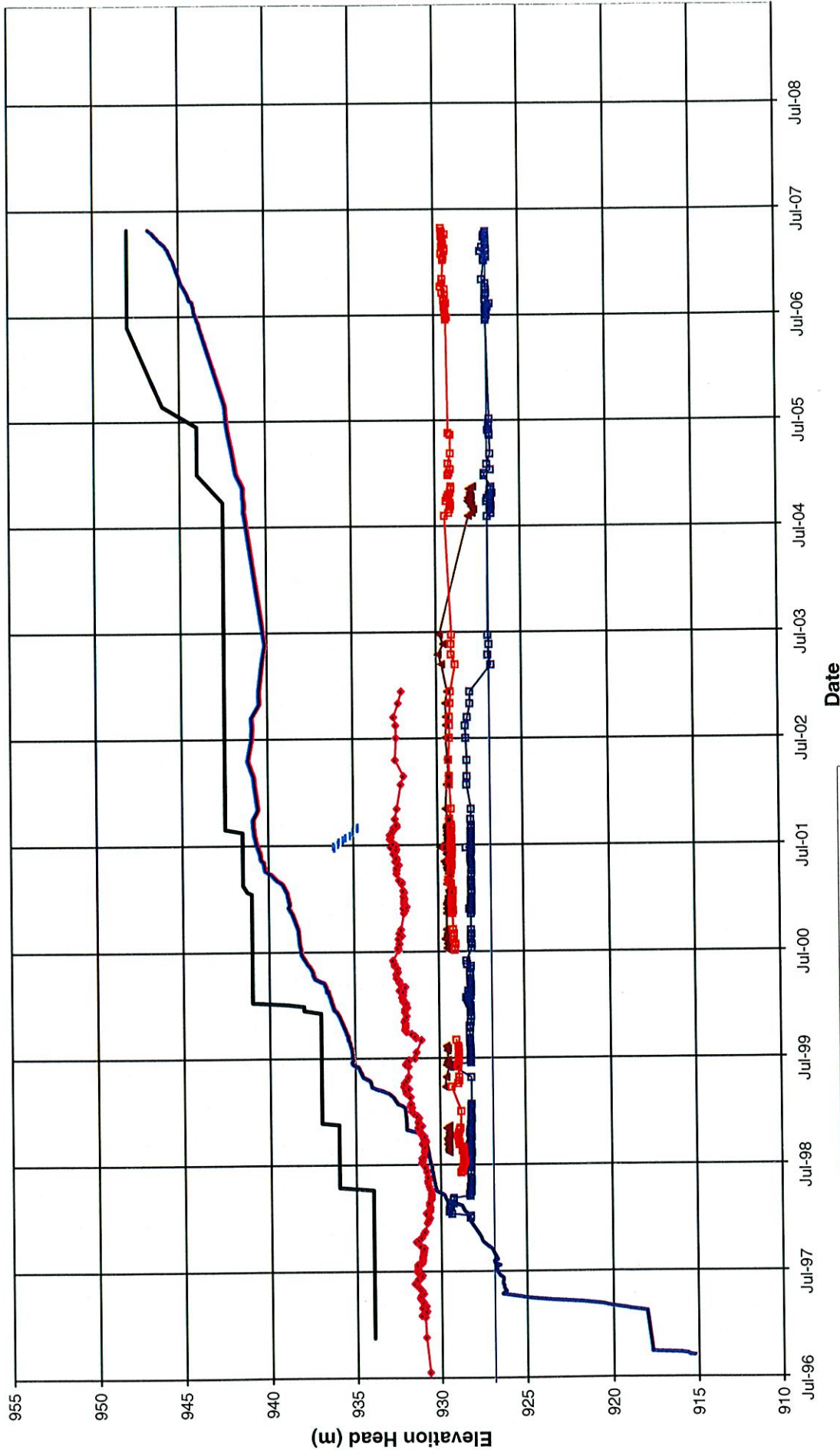

Note:
 1. Piezometers in parenthesis no longer functioning.
 2. Figure does not show the Stage 5 and Stage 6 piezometers as they have yet to be installed.

Legend:

- Pond Level
- Fill Elevation
- D1-PE1-02
- D2-PE2-02
- D1-PE1-03
- D2-PE1-01

MOUNT POLLEY MINING CORPORATION
 MOUNT POLLEY MINE
 TAILINGS STORAGE FACILITY
 PLANE D PIEZOMETERS
 GRAPH OF ELEVATION HEAD vs. TIME

PROJECT NO. VA 101-1/18
 REF. NO. 1
 REV. 0

Knight Piésold
 CONSULTING

FIGURE B-4

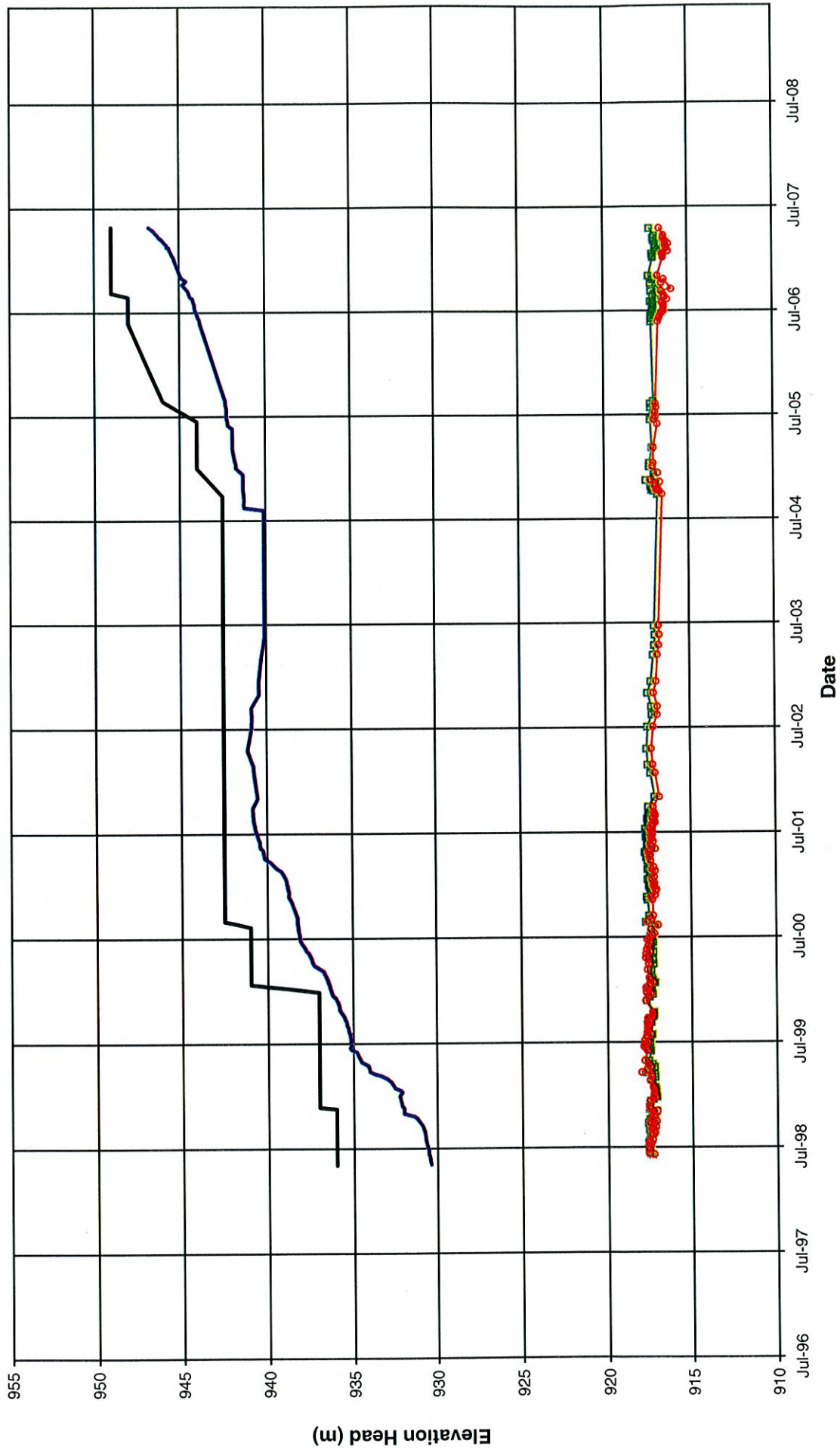

Note:
 1. Piezometers in parenthesis no longer functioning.
 2. Figure does not show the Stage 5 and Stage 6 piezometers as they have yet to be installed.

MOUNT POLLEY MINING CORPORATION	
MOUNT POLLEY MINE	
TAILINGS STORAGE FACILITY PLANE E PIEZOMETERS	
GRAPH OF ELEVATION HEAD vs. TIME	
PROJECT NO.	REF. NO.
VA 101 - 1/18	1
REV	0
Knight Piésold CONSULTING	
FIGURE B-5	

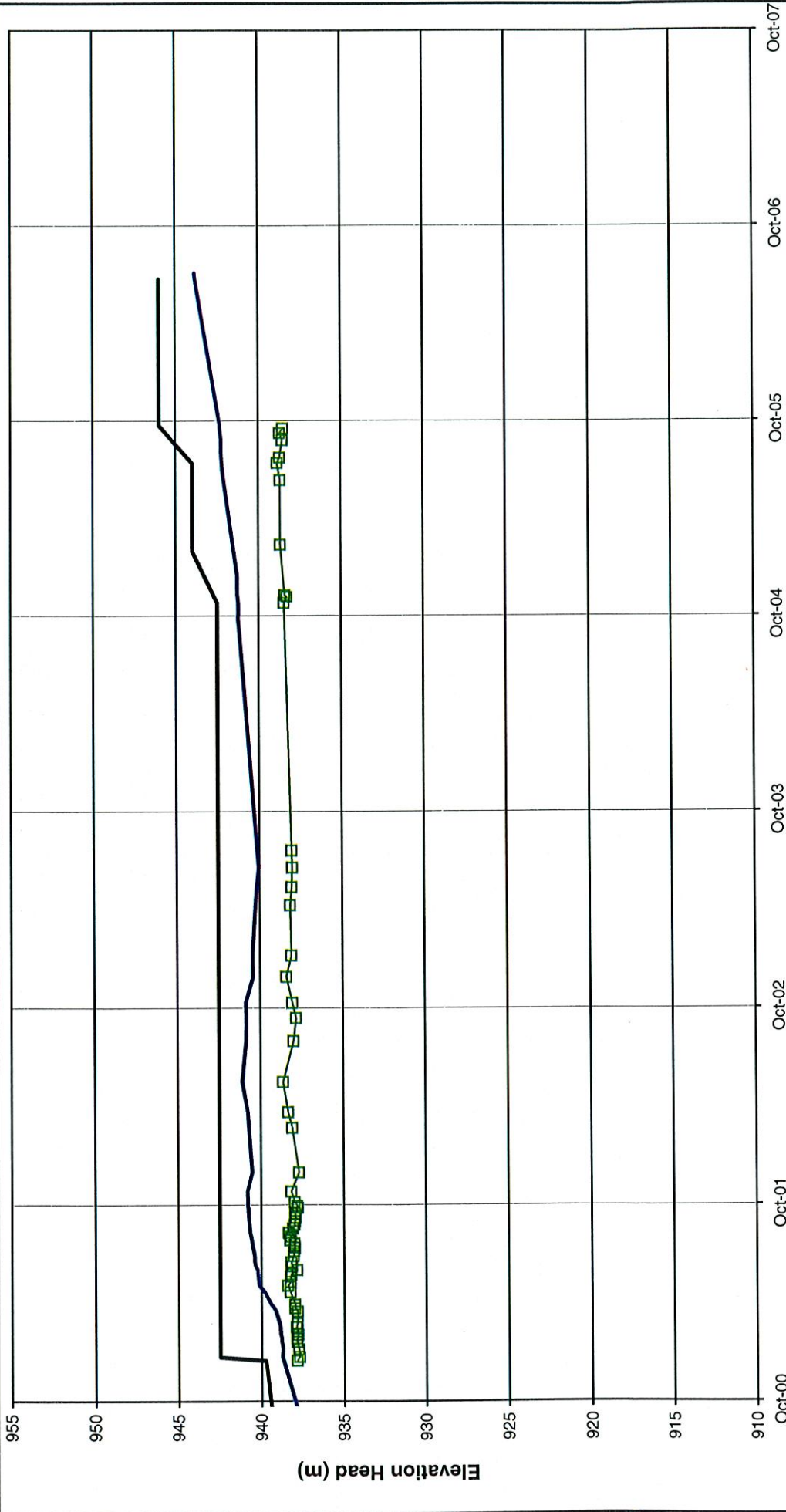

Date



Note:

1. Piezometers in parenthesis no longer functioning.
2. Figure does not show the Stage 5 and Stage 6 piezometers as they have yet to be installed.

MOUNT POLLEY MINING CORPORATION

MOUNT POLLEY MINE

PLANE F FOUNDATION PIEZOMETERS
ELEVATION HEAD vs. TIME

PROJECT NO.	REF. NO.	REV.
VA 101 - 1/18	1	0

Knight Piésold
CONSULTING

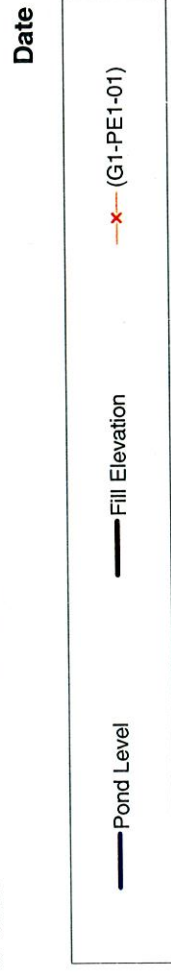
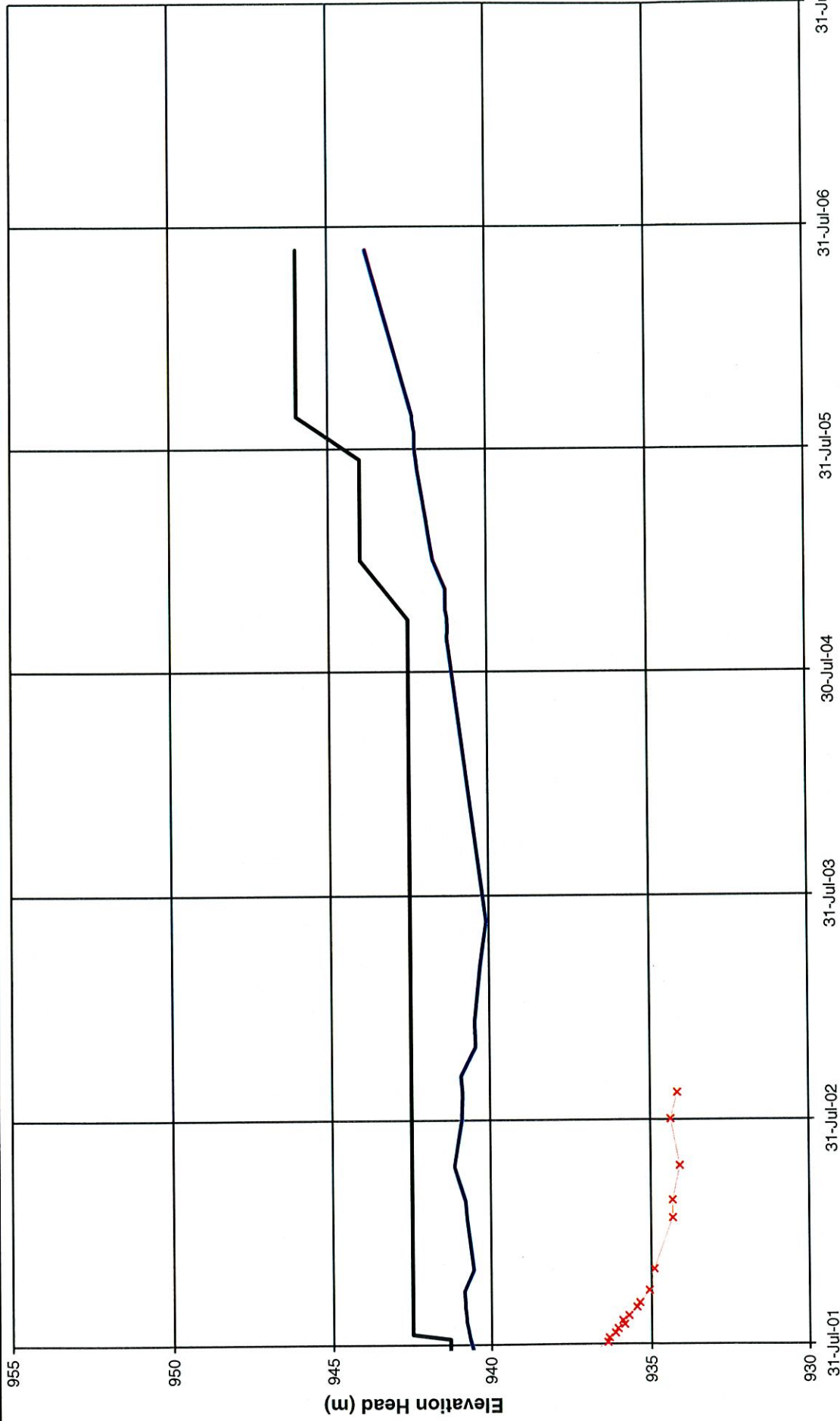

Note:
 1. Piezometers in parenthesis no longer functioning.
 2. Figure does not show the Stage 5 and Stage 6 piezometers as they have yet to be installed.

MOUNT POLLEY MINING CORPORATION
MOUNT POLLEY MINE

**PLANE G DRAIN PIEZOMETERS
ELEVATION HEAD vs. TIME**

PROJECT NO. VA 101 - 1/18	REF. NO. 1
REV. 0	

Knight Piesold
CONSULTING

FIGURE B-7

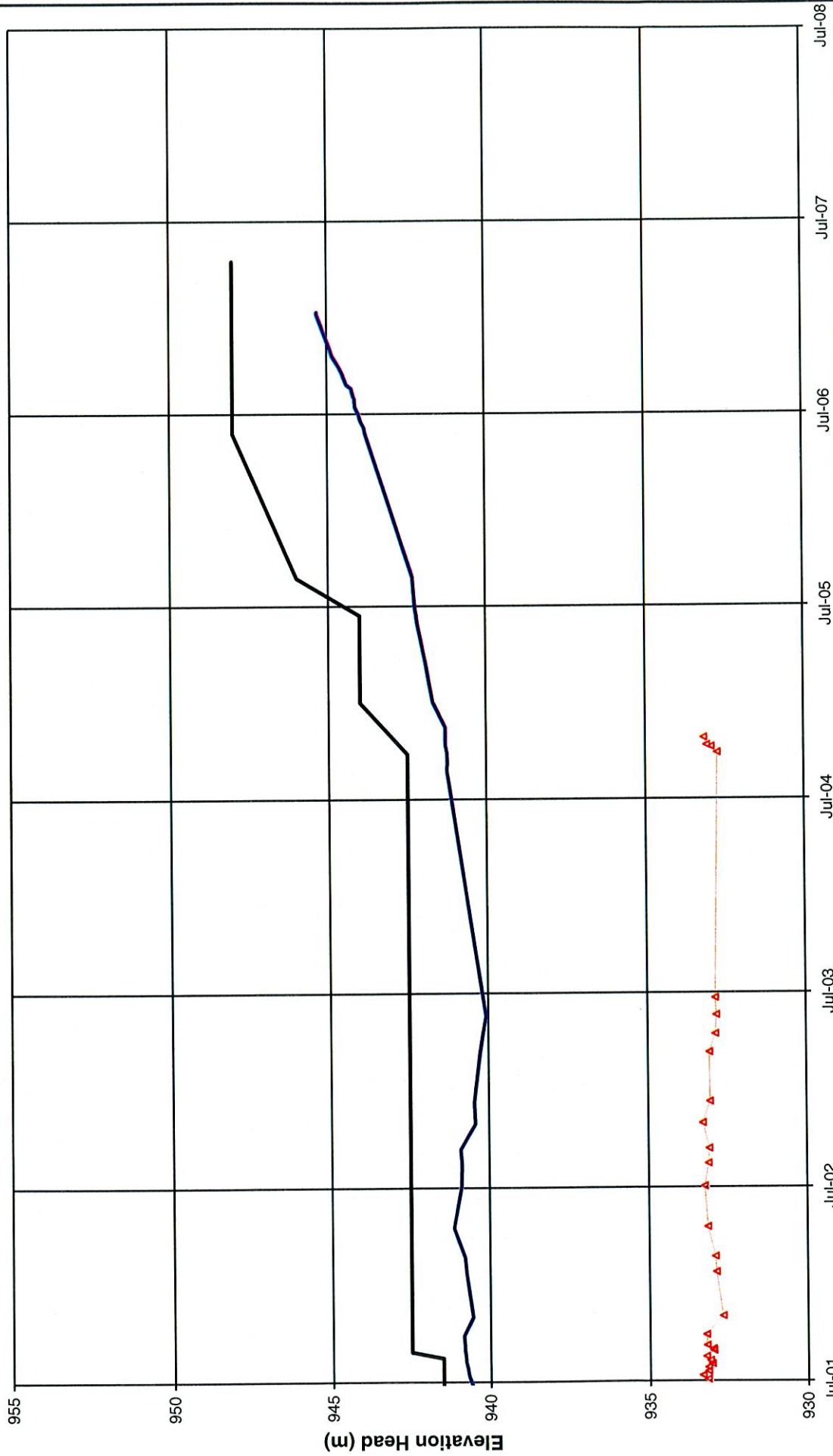

Mount Polley Mining Corporation

MOUNT POLLEY MINE

**PLANE H DRAIN PIEZOMETERS
ELEVATION HEAD vs. TIME**

Knight Piesold
CONSULTING

PROJECT NO.	REF. NO.	REV.
VA 101 - 1/18	1	0

FIGURE B-8

Date

— Pond Level

— Fill Elevation

▲ (H1-PE1-01)

- Note:
1. Piezometers in parenthesis no longer functioning.
 2. Figure does not show the Stage 5 and Stage 6 piezometers as they have yet to be installed.

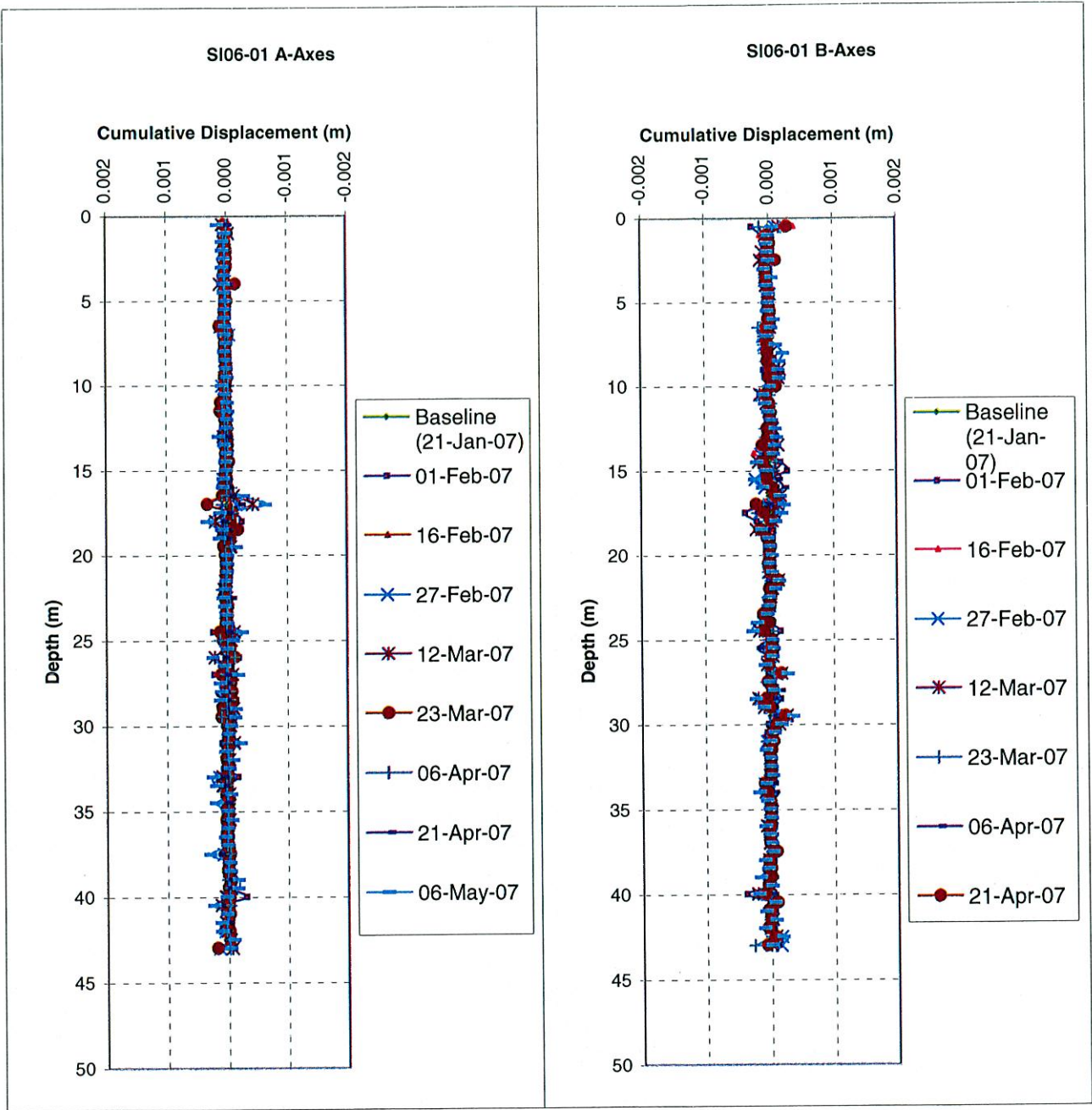

Notes:

- 1) Displacement is calculated based on the initial data set.
- 2) New data started in Feb., 2007 as a new probe was purchased.

MOUNT POLLEY MINING CORPORATION		
MOUNT POLLEY MINE		
TAILINGS STORAGE FACILITY INCLINOMETER SI06-01 DEPTH VS CUMULATIVE DISPLACEMENT		
<i>Knight Piésold</i> CONSULTING	PROJECT / ASSIGNMENT NO. VA101-1/18	REF NO. 1
	FIGURE B-9	
		REV 0

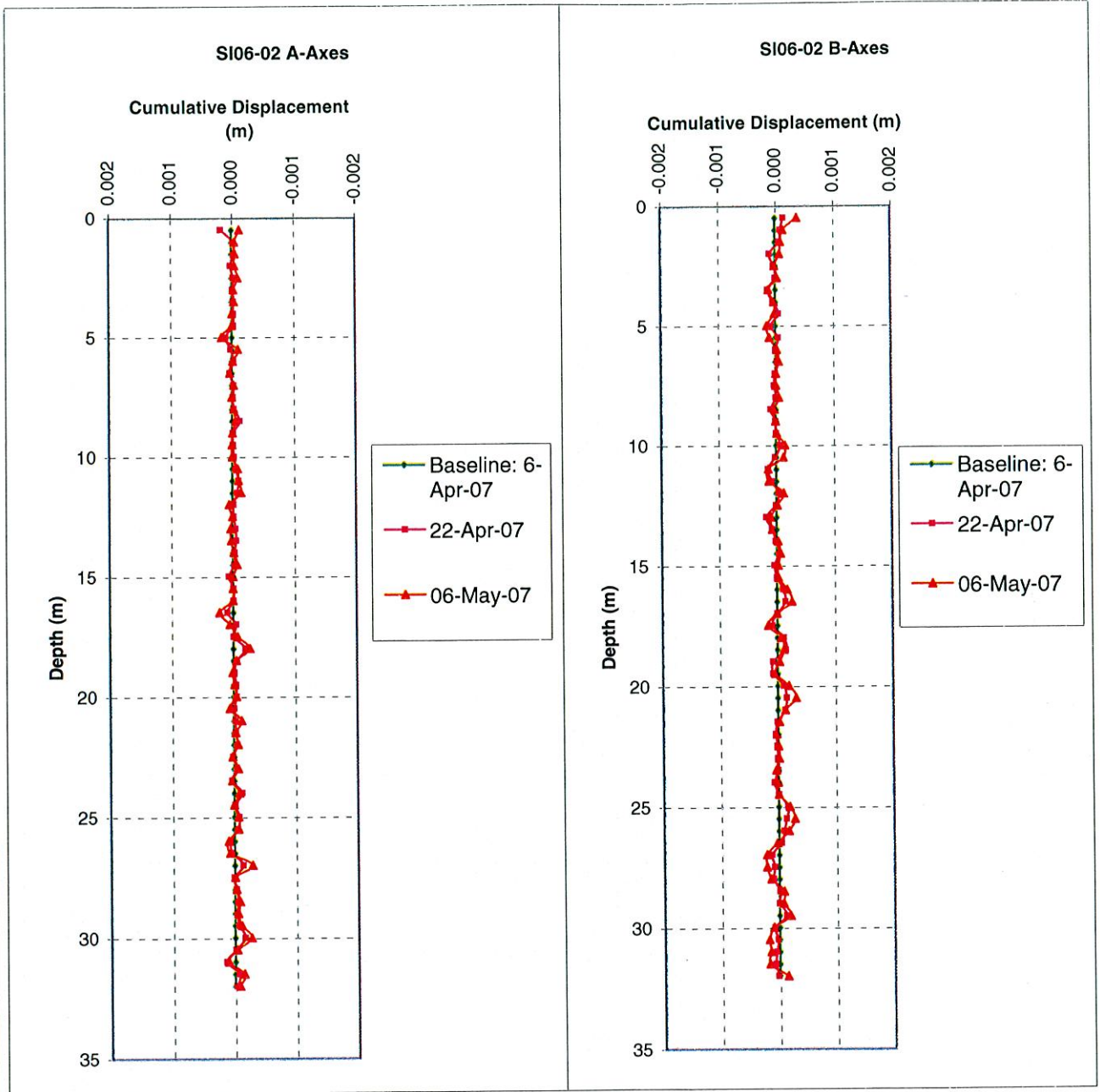

Notes:

- 1) Displacement is calculated based on the initial data set.
- 2) New data started in Apr., 2007 as a new probe was purchased.
- 3) SI06-02 was blocked by ice during the 06/07 winter.

Rev 0 - Issued with Stage 6 Design Report

MOUNT POLLEY MINING CORPORATION		
MOUNT POLLEY MINE		
TAILINGS STORAGE FACILITY INCLINOMETER SI06-02 DEPTH VS CUMULATIVE DISPLACEMENT		
<i>Knight Piésold</i> CONSULTING	PROJECT / ASSIGNMENT NO. VA101-1/18	REF NO. 1
	FIGURE B-10	
		REV. o

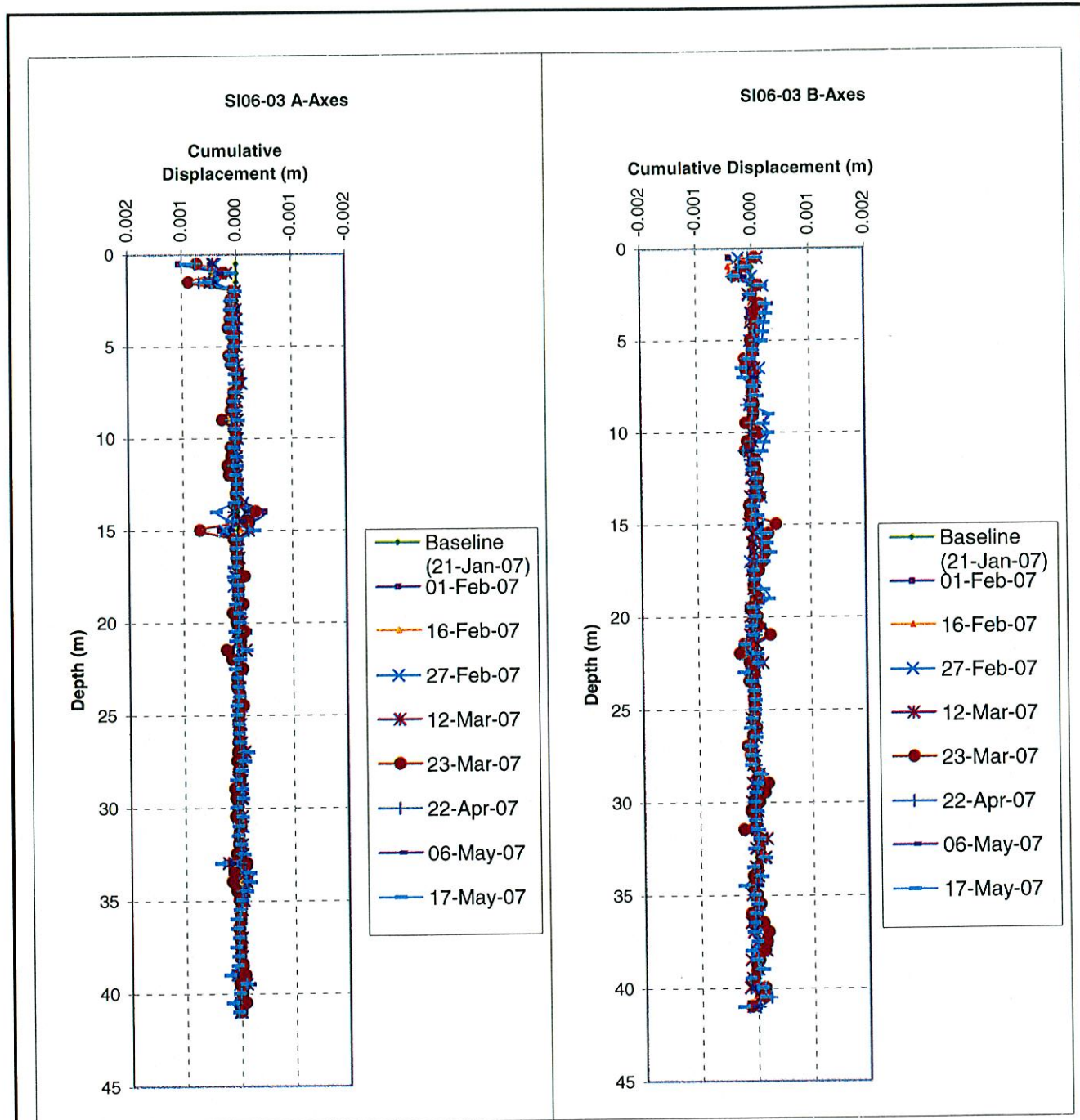

Notes:

- 1) Displacement is calculated based on the initial data set.
- 2) New data started in Feb., 2007 as a new probe was purchased.

MOUNT POLLEY MINING CORPORATION	
MOUNT POLLEY MINE	
TAILINGS STORAGE FACILITY INCLINOMETER SI06-03 DEPTH VS CUMULATIVE DISPLACEMENT	
<i>Knight Piésold</i> CONSULTING	PROJECT / ASSIGNMENT NO. VA101-1/18
	REF NO. 1
FIGURE B-11	
	REV. 0

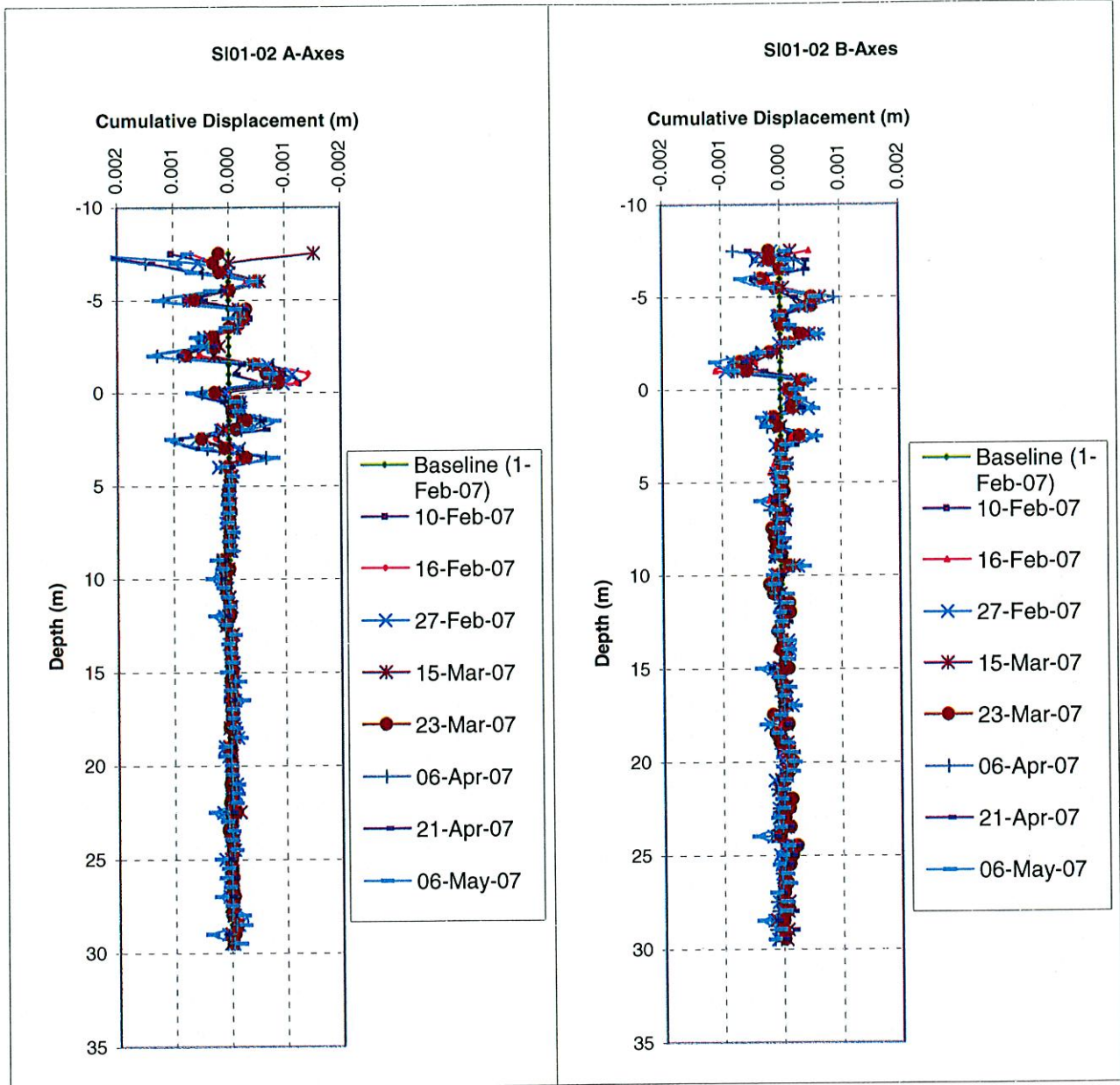

Notes:

- 1) Displacement is calculated based on the initial data set
- 2) New data started in Feb., 2007 as a new probe was purchased.

Rev 0 - Issued with Stage 6 Design Report

MOUNT POLLEY MINING CORPORATION		
MOUNT POLLEY MINE		
TAILINGS STORAGE FACILITY INCLINOMETER SI01-02 DEPTH VS CUMULATIVE DISPLACEMENT		
<i>Knight Piésold</i> CONSULTING	PROJECT / ASSIGNMENT NO. VA101-1/18	REF NO. 1
	FIGURE B-12	
		REV. 0

APPENDIX C

UPSTREAM TOE DRAIN SEEPAGE ESTIMATION

(Pages C1 to C7)

Our Reference: VA101-1/14-A.01
Continuity Nbr.: VA07-00362

March 14, 2007

Mr. Ron Martel
Mount Polley Mining Corp.
P.O. Box 12
Likely, B.C. V0L 1N0

Dear Ron,

Re: Mt. Polley Mine - Upstream Toe Drain Seepage Estimations

The Tailings Storage Facility (TSF) at Mount Polley Mine includes the Perimeter, Main, and South Embankments. The TSF embankments consist of zoned, earthfill structures that are progressively raised during operations using the modified centreline construction method. Embankment drainage provisions have been incorporated into the design of the TSF to facilitate drainage of the tailings mass, dewater the foundation soils, and to control the phreatic surface within the embankments. The components of the drainage systems consist of foundation drains, chimney drains, longitudinal drains, outlet drains, and upstream toe drains. The TSF currently has two upstream toe drains installed in the TSF embankments; one located in the Main Embankment at elevation 936 m, and one located in the Perimeter Embankment at elevation 945 m. A third toe drain may be installed on the South Embankment during Stage 6 construction program. The purpose of the upstream toe drains is to drain and consolidate the tailings mass near the embankments. The upstream toe drains also remove a certain amount of filtered water from the impoundment that is currently being recycled back into the TSF but may be a potential source of water available for discharge should the water quality objectives be met. The location of the upstream toe drains currently installed along the Main and Perimeter embankments are shown on Figure 1.

The Mount Polley Mine Site is currently operating in a water surplus condition with the excess water being stored in the TSF. Mount Polley Mining Corporation (MPMC) has requested that Knight Piésold review the current flow data from the upstream toe drain at the Main Embankment (the Perimeter Embankment upstream toe drain that was installed during the Stage 5 construction program has not yet started to flow) and provide future flow estimates from the upstream toe drains installed at each of the embankments.

UPSTREAM TOE DRAIN FLOW RATES

The upstream toe drain at the Main Embankment flows into the sump at the Main Embankment Seepage Collection Pond where the flows are measured. The flow rates have been measured since July 2000; however the flow rates from the drains were not monitored during the Care and Maintenance Period as the drain outlets were submerged within the sump. This condition was anticipated during the Care and Maintenance Period, as flow monitoring is only possible during operations when the seepage pond level has been pumped down. The seepage pond was pumped down in December 2005 and flow measurements were taken. The monitored flows were consistent with the flows measured in 2000. The flows from the Main Embankment upstream toe drain have increased since 2005, with the current flows ranging from 9 to over 12 l/s. The flow rates for the Main Embankment upstream toe drain are shown on Figure 2.

Knight Piésold Ltd.
Suite 1400
750 West Pender Street
Vancouver, British Columbia
Canada V6C 2T8

Telephone: 604.685.0543
Facsimile: 604.685.0147
Email: vancouver@knightpiesold.com



The flow rates were also modelled with the finite element computer program SEEP/W. The results of the modelling indicate that the flow rates for the upstream toe drain at the Main Embankment are impacted by the tailings beach profile along the embankment, the distance the supernatant pond is from the embankment, the location of tailings discharge point or points, and the degree of tailings consolidation above the toe drain. The most significant factors contributing to the flow rates in the upstream toe drain are the size of the tailings beach and the distance of the supernatant pond from the embankment. The tailings beach and pond location for October 31, 2006 are shown on Figure 3.

Stage 4 construction of the TSF embankments included using compact tailings sand as construction material in the upstream Zone U shell zone. This was accomplished by developing sand cells upstream of the core zone and discharging tailings into the cells. The coarse tailings settled out into the sand cells with the finer tailings exiting the cells via culverts installed in the upstream confining berms. This proved to be a successful construction technique for building Zone U but the prolonged discharging of tailings at the Perimeter Embankment resulted in the migration of the supernatant pond towards the Main Embankment, with the pond coming into direct contact with the Main Embankment at certain locations. This has resulted in higher flow rates for the upstream toe drain at the Main Embankment.

MPMC is currently in the process of procuring the HDPE pipe required to expand the tailings discharge pipeline around the entire facility. Evenly discharging the tailings from around the facility optimizes the development of tailings beaches and keeps the supernatant pond clear of the embankments, thereby increasing seepage paths and reducing seepage rates at the upstream toe drains. Beached tailings, when left to drain and consolidate, form the competent foundation needed for the modified centreline construction of embankment raises. The current flow rates from the Main Embankment upstream toe drain are considered to be elevated based on the proximity of the supernatant pond and will likely decrease, possibly by as much as 50%, with the development of a tailings beach in this area.

The estimated upstream toe drain flow rates for the Main, Perimeter, and South Embankments are shown on Figure 4. The flow estimates for the Perimeter and South Embankment upstream toe drains have been based on extrapolating the current measured flows in the Main Embankment upstream toe drain over the differential length of their drains. The figure also shows the estimated upper and lower flow boundaries (+/- 50%) for all three drains. The lower bound value is the conservative flow value and should be the value used in site water balance calculations. The upper bound value is a conservative flow value for the design of the settling ponds and associated pipe works. The lower bound values for the three upstream toe drains are as follows:

- Main Embankment 6 l/s (500 m³/day);
- Perimeter Embankment 7 l/s (640 m³/day);
- South Embankment 4 l/s (360 m³/day);
- The total lower bound flow rate assuming all drains in operation is estimated to be: 17 l/s (1500 m³/day).

The upper bound values for the three upstream toe drains are as follows:

- Main Embankment 17 l/s (1500 m³/day);
- Perimeter Embankment 22 l/s (1920 m³/day);
- South Embankment 13 l/s (1080 m³/day);
- The total upper bound flow rate assuming all drains in operation is estimated to be: 52 l/s (4500 m³/day).

The estimated flow rates from the upstream toe drains assume that all three are in operation and working effectively. The time line for the flow rates also assumes that the flows will appear in the Perimeter Embankment drain in April or May 2007 pending pumping of the Cariboo Pit water and that the upstream toe drain planned for the South Embankment during Stage 6 will be producing water in August 2008.

The upstream toe drain flow rates will vary at each embankment depending on the location of the supernatant pond. However, the overall flow rates from the TSF upstream toe drains are likely to remain fairly constant as increased flow rates resulting from the tailings pond having moved closer to one embankment will likely be offset by the reduction in flow rates from the opposite embankment that the tailings pond has subsequently moved away from.

It is important to reiterate that the main purpose of the upstream toe drains is to drain and consolidate the tailings mass near the embankments, not to remove large quantities of water from the TSF. It is therefore very important to continue measuring the flow rates from the upstream toe drains at regular intervals, along with the location of the supernatant pond, to determine whether the flow rates are significant enough or if other sources of water for discharge need to be considered.

We trust that the estimated flow rates from the upstream toe drains meets your current needs for updating the site water balance and sizing the settling ponds and associated pipe works. Please feel free to contact us if you have any questions.

Yours truly,

KNIGHT PIESOLD LTD.

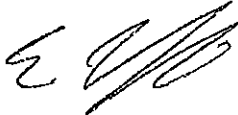

Eric Coffin
Staff Engineer



Ken Brouwer, P.Eng.
Managing Director

Encl:	Figure 1 Rev 0	Upstream Toe Drain Locations
	Figure 2 Rev 0	Main Embankment Upstream Toe Drain Flows
	Figure 3 Rev 0	Tailings Beach Profile
	Figure 4 Rev 0	Long Term Upstream Toe Drain Flow Estimations

/ec

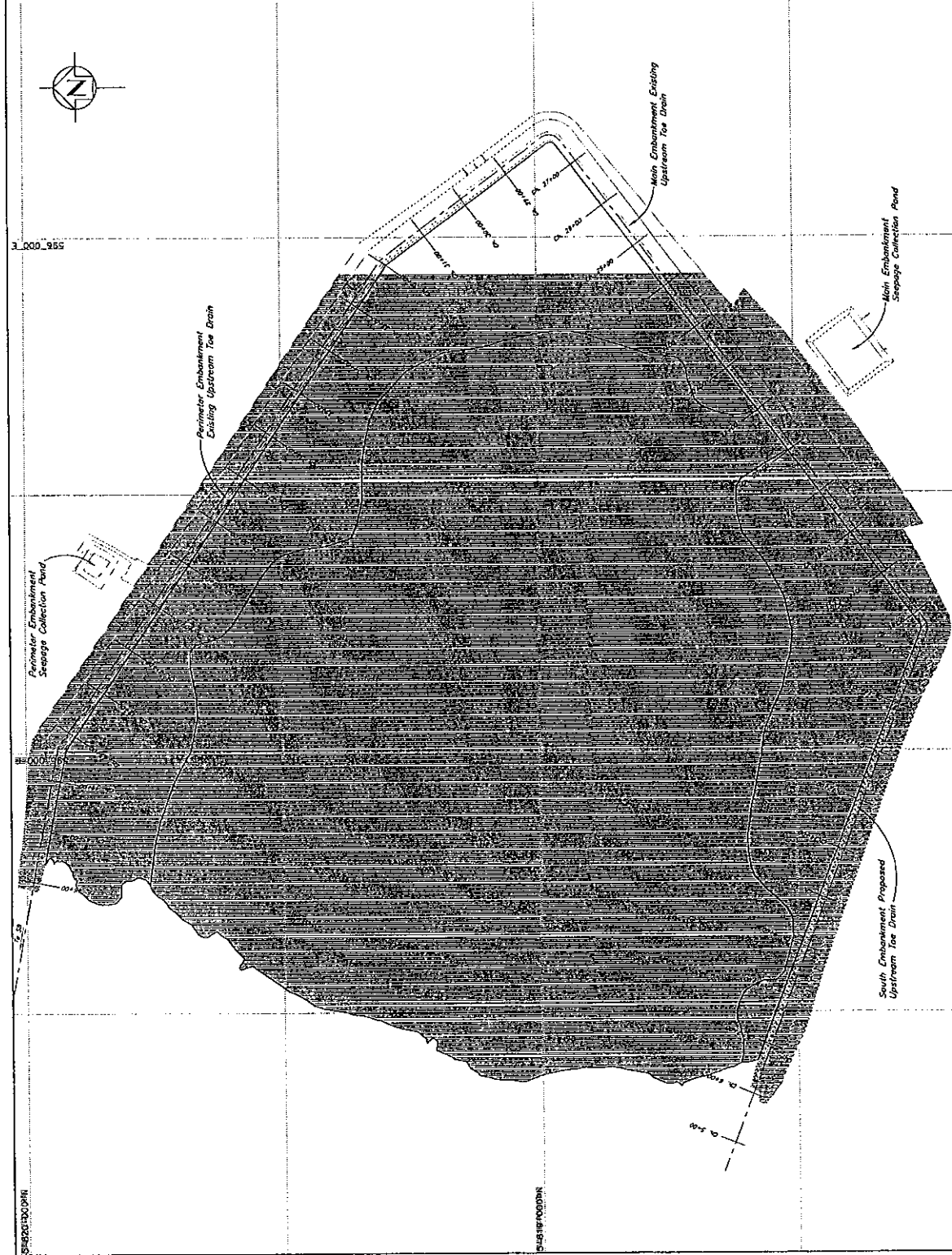

Scale 0 50 100 150 200 250 m

MOUNT POLLEY MINE CORPORATION
MOUNT POLLEY MINE
TAILINGS STORAGE FACILITY
UPSTREAM TOE DRAIN LOCATIONS
PROJECT/STANDARD NO. WAD01-1714
REV. NO. WADP-00365
DATE 0
FIGURE 1
CONSULTING

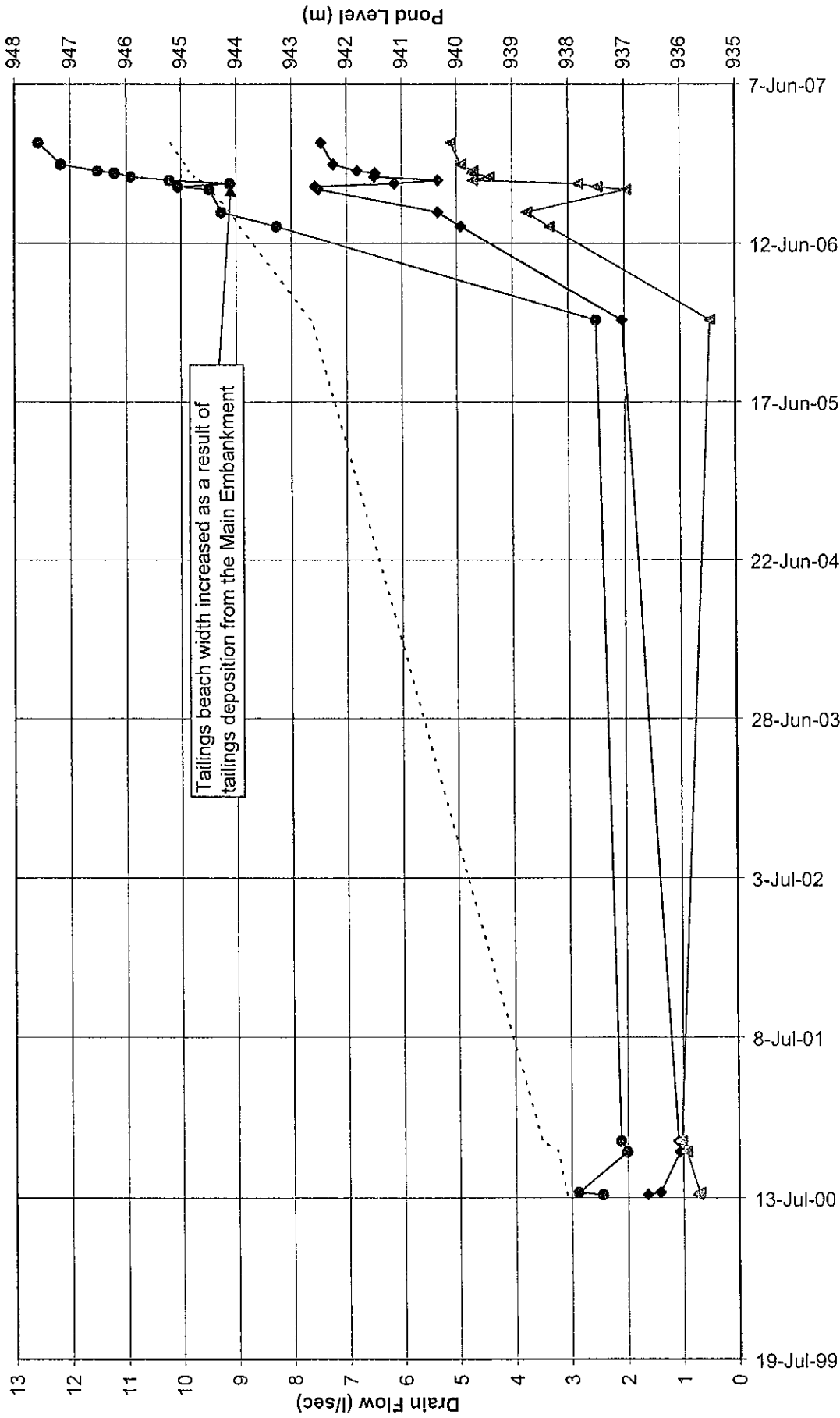

Tailings beach width increased as a result of tailings deposition from the Main Embankment

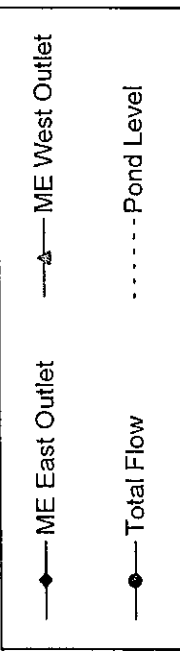

MOUNT POLLEY MINING CORPORATION
MOUNT POLLEY MINE

TAILINGS STORAGE FACILITY
MAIN EMBANKMENT UPSTREAM TOE DRAIN FLOWS

Knight Piésold
CONSULTING

PROJECT / ASSIGNMENT NO.
VA01-00001/14-A

REF NO.
VA07-00362

REV.
0

FIGURE 2

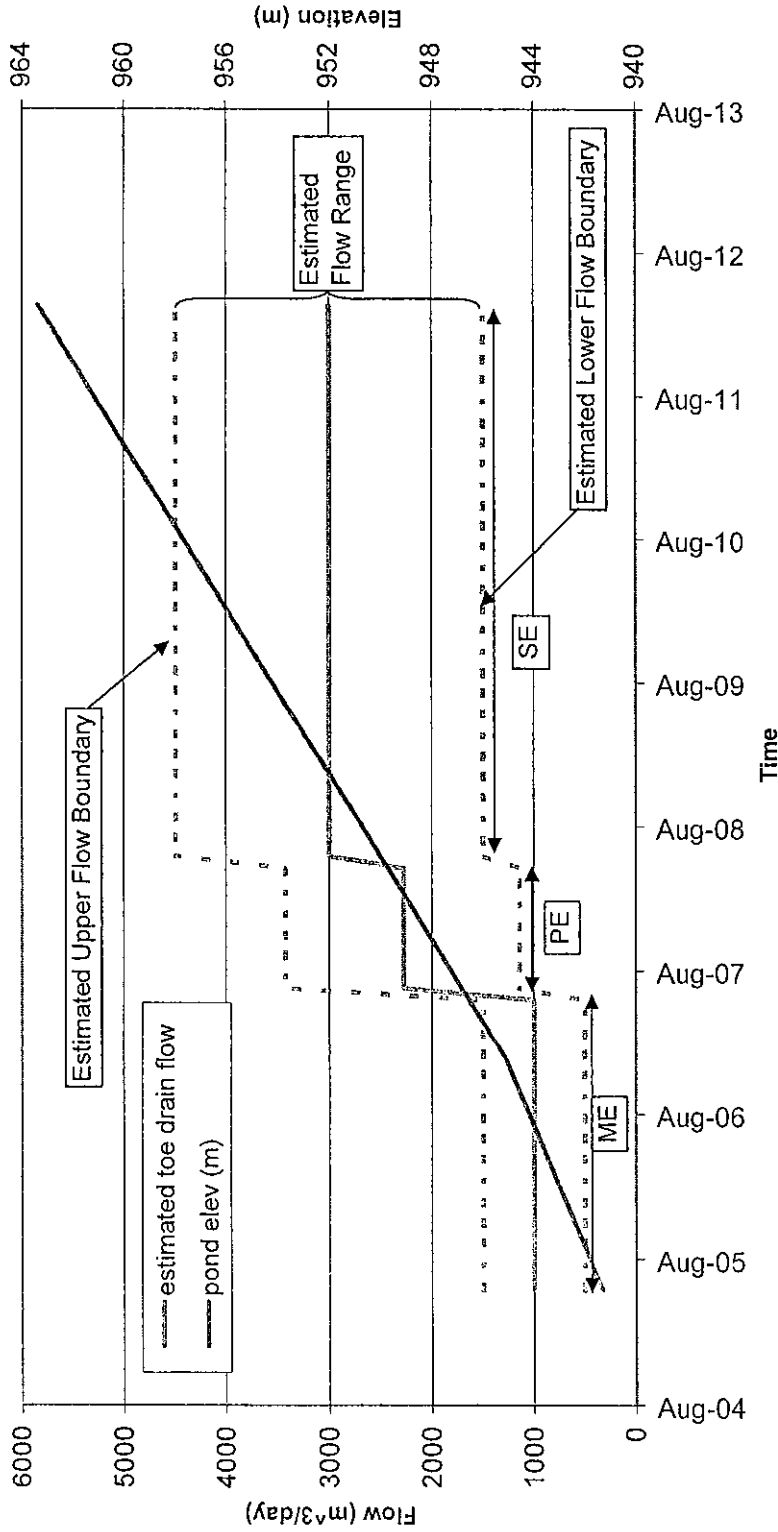

Notes:

- 1) Estimated upper flow assumes a 50% increase from the estimated flow
- 2) Estimated lower flow assumes a 50% decrease from the estimated flow

Rev 0 - Issued with Letter VA07-00362

MOUNT POLLEY MINING CORPORATION		PROJECT / ASSIGNMENT NO. VA01-0000114-A	REF NO. VA07-00362
MOUNT POLLEY MINE		FIGURE 4	
TAILINGS STORAGE FACILITY			
LONG TERM UPSTREAM TOE DRAIN FLOW ESTIMATES			
<i>Knight Piésold</i> CONSULTING		REV. 0	